



European  
Commission

## JRC TECHNICAL REPORT

# Energy Smart Appliances' Interoperability: Analysis on Data Exchange from State- of-the-art Use Cases

*Supporting the development of  
policy proposals for energy smart  
appliances.*

*Papaioannou, I.,  
Andreadou, N.,  
Tarramera Gisbert, A.*

This publication is a Technical report by the Joint Research Centre (JRC), the European Commission's science and knowledge service. It aims to provide evidence-based scientific support to the European policymaking process. The scientific output expressed does not imply a policy position of the European Commission. Neither the European Commission nor any person acting on behalf of the Commission is responsible for the use that might be made of this publication. For information on the methodology and quality underlying the data used in this publication for which the source is neither Eurostat nor other Commission services, users should contact the referenced source. The designations employed and the presentation of material on the maps do not imply the expression of any opinion whatsoever on the part of the European Union concerning the legal status of any country, territory, city or area or of its authorities, or concerning the delimitation of its frontiers or boundaries.

#### **Contact information**

Name: Ioulia Papaioannou

Address: European Commission, Joint Research Centre (JRC), Unit C.3., Westerduinweg 3, 1755 ZG - Petten, The Netherlands

Email: ioulia.papaioannou@ec.europa.eu

#### **EU Science Hub**

Luxembourg: Publications Office of the European Union, 2020

© European Union, 2022



The reuse policy of the European Commission is implemented by the Commission Decision 2011/833/EU of 12 December 2011 on the reuse of Commission documents (OJ L 330, 14.12.2011, p. 39). Except otherwise noted, the reuse of this document is authorised under the Creative Commons Attribution 4.0 International (CC BY 4.0) licence (<https://creativecommons.org/licenses/by/4.0/>). This means that reuse is allowed provided appropriate credit is given and any changes are indicated. For any use or reproduction of photos or other material that is not owned by the EU, permission must be sought directly from the copyright holders.

All content © European Union, 2022

How to cite this report: Papaioannou Ioulia, Andreadou Nikoleta, Tarramera Gisbert Angel, Energy Smart Appliances' Interoperability: Analysis on Data Exchange from State-of-the-art Uses Cases, EUR (where available), Publications Office of the European Union, Luxembourg, 2022.

# Contents

|   |    |
|---|----|
| Abstract.....   | 1  |
| Acknowledgements.....   | 2  |
| 1 Introduction.....   | 3  |
| 1.1 Background.....   | 3  |
| 1.2 Categorization of Energy Smart Appliances.....  | 4  |
| 2 Policy Background.....  | 8  |
| 3 Literature Review and Consolidation of Input on Interoperability of Energy Smart Appliances.....  | 9  |
| 3.1 First Phase of the <i>Ecodesign Preparatory Study on Smart Appliances (Lot 33): Methodology for Ecodesign of Energy-related Products (MEErP) Tasks 1-6</i> .....  | 9  |
| 3.2 Second Phase of the <i>Ecodesign Preparatory Study on Smart Appliances (Lot 33): Methodology for Ecodesign of Energy-related Products (MEErP) Task 7</i> .....  | 10 |
| 3.3 Interconnect – Deliverable 1.2: Mapping between Use Cases and Large-scale Pilots.....   | 12 |
| 3.4 Interconnect - Deliverable 5.2: Data Flow Management.....   | 17 |
| 3.5 European Smart Grids Task Force - Expert Group 1 – Standards and Interoperability.....  | 18 |
| 3.5.1 “My Energy Data” Report.....  | 18 |
| 3.5.2 Towards Interoperability within the European Union for Electricity and Gas Data Access and Exchange.....  | 19 |
| 3.6 Public Available Specification (PAS) 1878:2021 Energy Smart Appliances – System Functionality and Architecture – This British Standard Institution (BSI).....   | 19 |
| 3.7 Policy Guidance for Smart, Energy-Saving Consumer Devices - The Electronic Devices & Networks Annex (EDNA) of the International Energy Agency’s (IEA) Energy Efficient End-Use Equipment (4E) Technology Collaboration Programme..... | 20 |
| 3.8 Are we getting the best out of Smart Home Technologies? The Role of Usability – Energy Efficient End-Use Equipment - Electronic Devices and Networks Annex – Use Centred Energy Systems.....  | 22 |
| 3.9 Summary.....  | 23 |
| 4 Use Cases for Energy Smart Appliances.....  | 24 |
| 4.1 Generic Use Cases on Energy Smart Appliances based on the Existence or Absence of a Gateway.....  | 24 |
| 4.2 Representation of Use Cases on Energy Smart Appliances based on the <i>Ecodesign Preparatory study on Smart Appliances, Task 7</i> .....  | 25 |
| 4.2.1 Explicit Demand Response Use Cases.....   | 25 |
| 4.2.2 Implicit Demand Response Use Cases.....   | 26 |
| 4.2.3 Local Optimal Energy Consumption Use Cases.....   | 26 |
| 4.2.4 Standalone Demand Response Use Cases.....   | 27 |
| 5 Principles of the Information Exchange of Energy Smart Appliances with their Ecosystem.....   | 28 |
| 5.1 Actors Interacting with Energy Smart Appliances.....  | 28 |
| 5.2 Information Exchange of Energy Smart Appliances.....  | 31 |
| 5.3 General Principles on Privacy, Safety and Cyber-security for Exchange of Energy Smart Appliances.....   | 35 |
| 5.3.1 Privacy.....  | 35 |
| 5.3.2 Safety.....   | 35 |
| 5.3.3 Cyber-security.....   | 35 |

|   |    |
|---|----|
| 6 Conclusions.....  | 36 |
| References.....   | 37 |
| List of Abbreviations and Definitions .....   | 38 |
| List of figures.....  | 40 |
| List of tables.....   | 42 |
| Annexes.....  | 43 |
| Annex 1: Categorization of Use Cases.....   | 43 |
| Annex 2: Using the Smart Applications Reference ontology (SAREF) to describe the General Use Cases..... | 62 |
| Annex 3: Information Exchange between Main Actors and Energy Smart Appliances.....                      | 70 |

## **Abstract**

Policy support for a wide-scale deployment of energy smart appliances seems a complex matter, crossing the fields of product and digital-related policy instruments. Any potential measure would not directly address energy efficiency, but instead will essentially seek to certify a specific 'energy-smart' behaviour of products.

In this project DG ENER and the Joint Research Centre would propose a Code of Conduct to the energy smart appliances manufacturers for adherence.

This report is a combination of following three initial talks, which are fundamental for the project:

- Literature review and consolidation of input from relevant sources on the interoperability of energy smart appliances such as the InterConnect project, standardisation efforts in other countries or regions (i.e. UK, California, etc.)
- Development of use cases for energy smart appliances.
- Definition of principles of data sharing among appliances, home and building automation systems, electric vehicle chargers, aggregators, Distribution System Operators, etc.

Stakeholders (industry, NGOs, academia) and Member States authorities will be involved in this process. Involvement and communication with stakeholders will be undertaken in a combination of questionnaires, webinars and physical meetings.

A dedicated European Commission services Task Force will be set up to coordinate this action and coordination between different policy areas, ensuring broader political buy-in.

## **Acknowledgements**

We would like to thank our colleagues from Directorate B “Just Transition, Consumers, Energy Efficiency and Innovation”, especially Mr Takoudis Georgios for his support, and our project manager, Mr Von Estorff Ulrik, for his contribution particularly during literature research.

## **Authors**

Papaioannou Ioulia, Andreadou Nikoleta, Tarramera Gisbert Angel

# 1 Introduction

## 1.1 Background

Under the Ecodesign and Energy Labelling legislative framework (Delnooz, 2018), a preparatory study for addressing energy smart appliances has been completed. The preparatory study established the scope for further work (i.e., selected product categories with the highest potential for demand response), validated the economic benefits that can be achieved by a large scale deployment of energy smart appliances, and proposed some generic technical requirements for those. As a general approach, the study proposed a non-mandatory measure (i.e., to help differentiate on the market the energy smart appliances and ensure their full interoperability, but not to ban 'non-smart' products from the market). However, the study's conclusion was that more work is needed in order to come up with a regulatory proposal.

A problem is that, whereas full interoperability among different products from various manufacturers is important, the use of regulatory instruments might not be able to ensure it. It would require compliance with a multitude of standards, some of them not yet (fully) developed. In addition, any such regulation would heavily rely on these standards (references to which might need to be included in the regulatory text), while the standards themselves are in a very rapid evolution (much faster than the regulatory cycles).

Thus, regulation seems inappropriate. On the other hand, rapid technological developments could also lead to the consolidation of different product ecosystems. These will use proprietary solutions and will inherently be incompatible -i.e., not interoperable- with each other. Therefore, while action could be taken by the European Commission (EC) for securing coherent developments on the market, adherence of industry to Policy support for a wide-scale deployment of energy smart appliances seems a complex matter, crossing the fields of product and digital-related policy instruments. Any potential measure would not directly address energy efficiency, but instead will essentially seek to certify a specific 'energy-smart' behaviour of products. Such a feature will be based on a combination of hardware and software. Thus, a potential measure seems a priori closer to the procedures used for third-party certification for IT-related products, than to those currently used in ecodesign.

Given the current challenges, a different approach should be explored, i.e., a Code of Conduct (CoC) to be proposed by the EC to the appliance manufacturers for adherence. The preparation/coordination of such a CoC could be undertaken by an EC services task force, as this would allow us to coordinate between different policy areas, ensure broader political buy-in and gather sufficient staff resources.

Attracting enough signatories for the CoC would guarantee a minimum market convergence towards the use of the Smart Application Reference (SAREF) as reference ontology and the use of open standards.

An instrumental milestone would be the development and wide stakeholder agreement of principles for data sharing among energy smart appliances, home & building automation systems, EV chargers, electricity storage systems, aggregators, distribution system operator (DSOs), etc.

The work should build on the activities of the newly started InterConnect project<sup>(1)</sup>, funded under Horizon 2020. Many relevant stakeholders are project partners, and the project itself intends to demonstrate (and develop/extend) the use of SAREF for ensuring interoperability for demand side flexibility. Thus, a natural continuation would consist of: i) developing the CoC, and ii) ensuring the adherence of a sufficient number of signatories, with enough market coverage in their fields.

Stakeholders (industry, NGOs, academia) and Member States authorities will be involved in the process at different stages do discuss draft documents and proposals. Involvement and communication with stakeholders will be undertaken in a combination of questionnaires, webinars and physical meetings (to the extent possible in light of the COVID pandemic). The coordination of stakeholders will be carried out jointly by DG ENER and the JRC.

In this deliverable JRC is presenting the following outcome:

- Literature review and consolidation of input from relevant sources on the interoperability of energy smart appliances such as the InterConnect project, standardisation efforts in other countries or regions (i.e. UK, California, etc.).

---

<sup>1</sup> <https://interconnectproject.eu/>.

- Development of use cases for energy smart appliances.
- Defining the principles for data sharing among appliances, home & building automation systems, EV chargers, aggregators, DSOs in collaboration with stakeholders

The report fulfils three tasks:

1. To present a thorough literature review:

The main reports used as reference are the Ecodesign preparatory study, the InterConnect project, the output from the Smart Grid Task Force Expert Group 1, the British standard, the Green Button Initiative, the respective work from the International Energy Agency (IEA) and from the Electronic Devices and Networks Annex (EDNA) among others. The most important messages resulted from the literature review have been consolidated and presented in Section 3.

2. To present Use Cases (UCs) for Energy Smart Appliances (ESAs):

The starting point for this task has been the UCs developed in the aforementioned reports. Four generic UCs have been produced and their message sequence diagrams are presented in Section 4. The detailed description of all UCs can be found in Annex 1.

3. To define the principles of data exchange:

The definition of principles of data exchange has been based on the previous task, and particularly on the sequence diagrams used to define the main functionalities, the major actors and the specific information that the energy smart appliances are generally exchanging with their ecosystem.

In Annex 2, the report describes the four Generic UCs using the SAREF interoperability language and, in Annex 3, the messages represented in the four generic UCs introduced in Section 4 are summed up in a unique table.

The last task sets the foundations of the four coming deliverables of this project where the interoperability requirements will be agreed, set and constitute the CoC.

As a future task, the goal is to develop the aforementioned UCs in IEC 62559-2 template <sup>(2)</sup> with the use of the JRC Smart Grid Design of Interoperability Tests platform <sup>(3)</sup>.

The purpose of this report is to set up a first draft where the interactions and information exchange of energy smart appliances is defined and agreed. For this reason, this report will constitute a living document which is going to be shared for consultation among the relevant stakeholders. This will be the first interaction in this topic with the stakeholders, such as manufactures, industry, associations etc. which will eventually lead to the co-development of interoperability requirements for energy smart appliances and the co-design of a CoC.

## 1.2 Categorization of Energy Smart Appliances

Energy Smart Appliance is a rather generic term that covers a variety of appliances; all of them should be able to respond to external signals and communicate with a device within the house, i.e. Home Energy Management System or directly with the energy provider.

A proper definition of energy smart appliances is required for establishing the baseline for this study. For this, we have used the definition given by Ecodesign preparatory study on Smart Appliances (Delnooz, 2018) – then further reviewed in Chapter 3:

---

<sup>(2)</sup> International standard - IEC 62559-2:2015. Use case methodology - Part 2: Definition of the templates for use cases, actor list and requirements list. s.l.: International Electrotechnical Commission (IEC). ISBN 978-2-8322-2656-8. ISBN 978-2-8322-2656-8. <https://webstore.iec.ch/publication/22349#additionalinfo>

<sup>(3)</sup> JRC-Smart Grid Design of Interoperability Test (SG-DoIT), <https://smart-interoperabilitytest.jrc.cec.eu.int/index.php>



Energy smart appliances - in its broadest sense, and not only limited to smart grid functionality – are mostly understood as appliances that are communication enabled. This communication platform can be used to implement multiple classes of functionality in the smart energy appliances.

A smart appliance is an appliance that supports the control of its energy consumption and hence it is able to apply Demand Side Flexibility:

- It is an appliance that is able to automatically respond to external stimuli e.g. price information, direct control signals, and/or local measurements (mainly voltage and frequency).
- The response is a change of the appliance's electricity consumption pattern. These changes to the consumption pattern is what we call the 'flexibility' of the smart appliance.

The flexibility potential of a group of appliances is defined by two parameters:

1. A shifting potential = amount of energy that can be shifted, expressed in [MWh/h].
2. Average maximal shifting period = average maximum number of hours [h] that appliance can be shifted (i.e., to consume later/earlier in time than initially planned).

A detailed categorization for the energy smart appliances is presented in this Section.

Energy smart appliances can have very different characteristics and thus, it is interesting to group them into broader categories. Such grouping can be found in various sources of this study, such as the Ecodesing Preparatory Study on Smart Appliances, Tasks 1-6 (Delnooz, 2018).

Therefore, we have the following categorization, according to the above referred report:

1. Periodical appliances:

Appliances that execute a periodic cycle indicated by the user; under this category we can find the following appliances: dish washers; washing machines; tumble dryers (electric vented, electric condenser, heat pump dryer); washer dryers. For this category of appliances, the energy is needed for heating purposes, i.e. water heating or hot air production.

2. Continuous appliances:

These appliances are able to store energy in a form ready to use by the final user. Such appliances are: refrigerators; freezers; electric storage water heater. The energy to consumed depends on various factors such as the total load to be cooled down, the frequency of door openings, the exposure to external heat (sun), the ambient temperature and humidity, the temperature set by the user.

3. Behavioural appliances:

These appliances function according to the users' needs and can be the following: electric ovens, electric hobs, vacuum cleaners, water heaters (kettles), and range hoods. As their name implies, energy is mainly used for heating purposes, whereas in the case of the vacuum cleaners, energy is used for sucking up objects and creating a vacuum.

4. Heating Ventilation Air Conditioning (HVAC) appliances:

As their name implies, these appliances are used for heating, ventilation and air conditioning purposes. Such appliances can be easily used for demand response purposes, provided that the user preferences and comfort are not violated. It should be also mentioned here, that heating and cooling demand varies a lot depending on the location of the users; for instance, in southern countries cooling needs are greater, whereas in northern countries heating needs are greater.

5. Battery operated rechargeable appliances:

This category covers a variety of appliances used on daily basis by consumers, like: multimedia appliances (mobile phones, tablets, laptops, etc); household appliances (shaving appliances, fans, vacuum cleaners, etc); power tools (garden machinery, screwdrivers, etc). Many of these appliances have a very low power that cannot be considered for load shifting and/or demand response programs. However, appliances with frequent charging patterns and appliances like smart phones, which have a growing volume in numbers, could be considered for load shifting. Constraints for these appliances can be set according to user comfort standards.

6. Residential energy storage system:

Different terms can be used for devices of this kind, like: storage battery for home use; residential energy storage system; solar energy storage unit; solar battery; home battery. Usually, a battery system is installed together with a Photovoltaic (PV) system. In general, a battery system can be an important asset for participating in energy shifting and/or demand response programs.

7. Lighting appliances:

As the name implies, in this category, there are the lighting appliances within the house, as well as public street lighting. Such lighting devices can be: LFL - Linear fluorescent lamp, CFL - Compact fluorescent light, tungsten, GLS – general lighting service, HID: High intensity discharge lamp, LED – light emitting diode. The main constraints for this category of appliances are comfort issues by the users.

It is worth noticing that electric vehicles are not included in this categorization of energy smart appliances. In general, the battery of the electric vehicle can be considered to belong under the broad category of the residential energy storage system, since it is a battery at the disposal of the consumer. It should be also highlighted that one smart appliance can be part of different classification clusters at the same time. The following table summarizes the introduced categories and the specific electrical devices under each category.

**Table 1.** Energy smart appliances categorization.

| <b>Smart Appliance category</b>          | <b>Electrical devices composing the category</b>  |
|--|---|
| Periodical appliances                    | Dish washers<br>Washing machines<br>Tumble dryers (electric vented, electric condenser, heat pump dryer)<br>Washer dryers   |
| Continuous appliances                    | Refrigerators<br>Freezers<br>Electric storage water heater  |
| Behavioural appliances                   | Electric ovens<br>Electric hobs<br>Vacuum cleaners<br>Water heaters (kettles)<br>Range hoods  |
| HVAC                                     | Heating appliances<br>Ventilation appliances<br>Air conditioning appliances   |
| Battery operated rechargeable appliances | Multimedia appliances (mobile phones, tablets, laptops, etc.)<br>Household appliances (shaving appliances, fans, vacuum cleaners, etc.)<br>Power tools (garden machinery, screwdrivers, etc.) |
| Residential energy storage system        | Storage battery for home use<br>Residential energy storage system<br>Solar energy storage unit<br>Solar battery<br>Home battery<br>Electrical vehicle   |

|                     |   |
|---------------------|---|
| Lighting appliances | Linear fluorescent lamp (LFL);<br>Compact fluorescent light (CFL);<br>Tungsten;<br>General lighting service (GLS);<br>High intensity discharge lamp (HID);<br>Light emitting diode (LED). |
|---------------------|---|

Source: JRC analysis, 2022.

## 2 Policy Background

The purpose of the work to be carried out under this Administrative Arrangement (hereafter referred to as Arrangement) is for JRC to provide DG ENER with technical and scientific assistance to support the development, implementation and review of relevant provisions of EU energy efficiency legislative framework Energy Efficiency Directive (Directive 2012/27/EU as amended by Directive (EU) 2018/2002) and the Energy Performance of Buildings Directive (Directive 2010/31/EU as amended by Directive (EU) 2018/844), including aspects related to the framework of the Governance Regulation (Regulation (EU) 2018/1999). The following policies have been consulted:

1. Energy Efficiency Directive <sup>(4)</sup>.
2. Energy Performance of Buildings Directive (Directive 2010/31/EU as amended by Directive [EU] 2018/844) <sup>(5)</sup>.
3. Governance Regulation (Regulation [EU] 2018/1999) <sup>(6)</sup>.
4. Ecodesign Directive <sup>(7)</sup>.
5. Energy Labelling Regulation <sup>(8)</sup>.

---

<sup>(4)</sup> 2018 O.J. (L 328) 35. 2018. *DIRECTIVE (EU) 2018/2002 OF THE EUROPEAN PARLIAMENT AND OF THE COUNCIL of 11 December 2018 amending Directive 2012/27/EU on energy efficiency*. Official Journal of the European Union. 2018, Vol. L 328, 210. [https://eur-lex.europa.eu/legal-content/EN/TXT/?uri=uriserv%3AOJ.L\\_.2018.328.01.0210.01.ENG](https://eur-lex.europa.eu/legal-content/EN/TXT/?uri=uriserv%3AOJ.L_.2018.328.01.0210.01.ENG)

<sup>(5)</sup> 2018 O.J. (L 156) 75. 2018. *DIRECTIVE (EU) 2018/844 OF THE EUROPEAN PARLIAMENT AND OF THE COUNCIL of 30 May 2018 amending Directive 2010/31/EU on the energy performance of buildings and Directive 2012/27/EU on energy efficiency*. Official Journal of the European Union. 2018, Vol. L 156, 75. [https://eur-lex.europa.eu/legal-content/EN/TXT/?uri=uriserv%3AOJ.L\\_.2018.156.01.0075.01.ENG](https://eur-lex.europa.eu/legal-content/EN/TXT/?uri=uriserv%3AOJ.L_.2018.156.01.0075.01.ENG)

<sup>(6)</sup> 2018 O.J. (L 328) 1. 2018. *REGULATION (EU) 2018/1999 OF THE EUROPEAN PARLIAMENT AND OF THE COUNCIL of 11 December 2018 on the Governance of the Energy Union and Climate Action, amending Regulations (EC) No 663/2009 and (EC) No 715/2009 of the European Parliament and of the Council, Directives 94/22/EC, 98/70/EC, 2009/31/EC, 2009/73/EC, 2010/31/EU, 2012/27/EU, 2013/30/EU of the European Parliament and of the Council, Council Directives 2009/119/EC and (EU) 2015/652 and repealing Regulation (EU) No 525/2013 of the European Parliament and of the Council*. Official Journal of the European Union. 2018, Vol. L 328, 1. [https://eur-lex.europa.eu/legal-content/EN/TXT/?uri=uriserv%3AOJ.L\\_.2018.328.01.0001.01.ENG](https://eur-lex.europa.eu/legal-content/EN/TXT/?uri=uriserv%3AOJ.L_.2018.328.01.0001.01.ENG)

<sup>(7)</sup> 2009 O.J. (L 285) 10. 2009. *DIRECTIVE 2009/125/EC OF THE EUROPEAN PARLIAMENT AND OF THE COUNCIL. Of 21 October 2009 establishing a framework for the setting of ecodesign requirements for energy-related products*. Official Journal of the European Union. 2009, Vol. L 285, 10. <https://eur-lex.europa.eu/legal-content/EN/ALL/?uri=CELEX%3A32009L0125>

<sup>(8)</sup> 2017 O.J. (L 198) 1. 2017. *REGULATION (EU) 2017/1369 OF THE EUROPEAN PARLIAMENT AND OF THE COUNCIL. Of 4 July 2017 setting a framework for energy labelling and repealing Directive 2010/30/EU*. Official Journal of the European Union. 2017, Vol. L 198, 1. <https://eur-lex.europa.eu/eli/reg/2017/1369/oj>

### **3 Literature Review and Consolidation of Input on Interoperability of Energy Smart Appliances**

This Section gives, as the name implies, a thorough literature review of the sources that address Interoperability for Smart Appliances, carried out through recent works. All these sources have been considered afterwards in order to analyse existing Use Cases on Smart Appliances and derive finally to the requirements of the data exchanged among smart appliances.

#### **3.1 First Phase of the Ecodesign Preparatory Study on Smart Appliances (Lot 33): Methodology for Ecodesign of Energy-related Products (MEErP) Tasks 1-6**

For the purpose of the Ecodesign Preparatory study (Delnooz, 2018), interoperability is understood as the communication and data exchange link between the individual appliance and the supply side (BRP – Balance Responsible Parties, aggregator, energy efficiency service provider, grid operator, etc.) via a home energy manager or internet/cloud systems and in some cases also the AMI (Advanced Metering Infrastructure), making it possible to achieve a better balancing of energy generation and energy consumption within the grid and/or to avoid grid congestion.

In the context of the smart home and energy smart appliances cross-platform, interoperability is an essential requirement to guarantee flexibility and security of possible investment for the customer.

Interoperability amongst energy smart appliances – including those of various manufacturers – must be ensured. The smart appliance shall be interoperable and communicate with/to other elements in the home such as the central energy manager and/or information display.

In addition, it will be in the interest of the consumers that the operation of the system is manageable even without expert knowledge, ideally in the sense of a "plug-and-play" solution, and this via an intuitively usable, integrated user interface. These system objectives require that the subsystems involved are syntactically and semantically interoperable, so the data is correctly exchanged, information and commands understood and correctly interpreted. The interchangeability of the subsystems requires the use of a technology neutral and standardised language, which is implemented through the relevant communication protocols.

Figure 1 details the data transfers between the appliance, the communication architecture (home energy gateway or cloud service provider), the energy service provider and possibly the aggregator. The 2 upper parts of the illustration show the 2 basic communication models, the Home Energy Gateway model and the Cloud model, respectively. The bottom part of the illustration explains the 3 layers.

The information layer contains the same information content from the aggregator to the appliance. The communication layer contains the specific protocols transmitting the information. Each protocol has its own encoding of the information content. The component layer contains the hardware component varying for each part of the communication system.

Both models each have their pros and cons. The gateway model requires the installation of extra hardware. However, the cloud model requires that each smart appliance (and measurement component) guarantees all on-board functionality to establish a stable and secure extra-house communication link (authentication, encryption, handling dynamic IP addresses, handling firewalls, etc.). The gateway model implies interoperable interfaces on the devices, whereas the cloud model shifts this interoperability problem up to the level of the communication between the servers.

An important reason why the cloud model emerged, is that appliance manufacturers are no longer dependent on a gateway provider to integrate their device and that it allows them to provide device specific functionality.

**Figure 1.** Data transfers between the appliances and the power system.

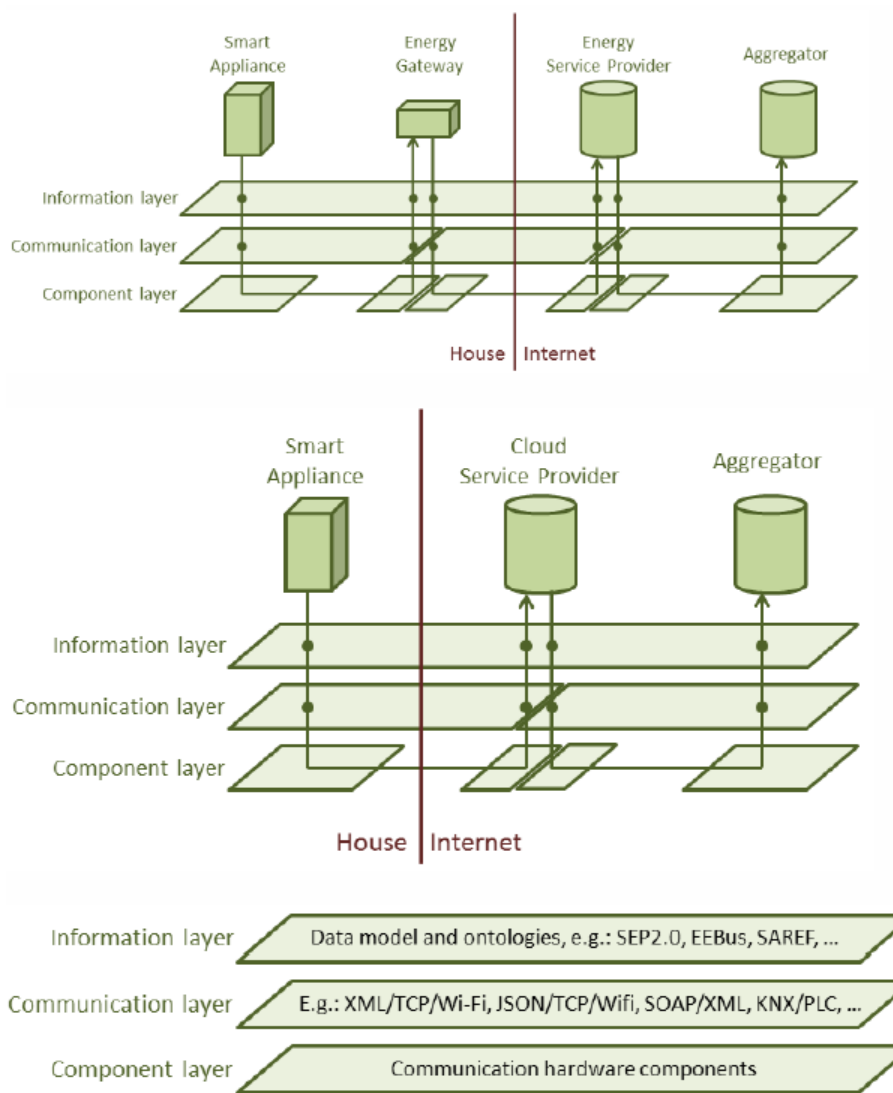

Source: (Delnooz, 2018).

### 3.2 Second Phase of the *Ecodesign Preparatory Study on Smart Appliances (Lot 33): Methodology for Ecodesign of Energy-related Products (MEErP) Task 7*

In this Task of the Ecodesign Preparatory work (Ectors, 2018) different use cases have been addressed. Demand side management at residential level is in its first steps of development and it is important to ensure that an energy smart appliance is flexible enough to be used in different business cases or use case configurations. The use cases were described from a customer/appliance point of view and 3 types of interface architectures were defined/observed in order to support a multitude of customer and system level use cases. By doing so, the business case interoperability concern has been translated into interface architecture requirements.

The report uses the architecture as proposed by the Smart Grid Coordination Group <sup>(9)</sup>-see Figure 2-. Whereas, Figure 3 gives an example of multiple energy smart appliances from different manufacturers all with their proper communication and protocol choices (e.g. Wi-Fi, ZigBee, wired IP, KNX, PLC) which have to be able to

<sup>(9)</sup> CEN-CENELEC-ETSI. 2012. *Smart Grid Coordination Group Smart Grid Reference Architecture*. 2012. Technical Report. [https://ec.europa.eu/energy/sites/ener/files/documents/xpert\\_group1\\_reference\\_architecture.pdf](https://ec.europa.eu/energy/sites/ener/files/documents/xpert_group1_reference_architecture.pdf)

communicate in an interoperable way with a CEM (Customer Engagement Management). The complexity though of the architecture and the challenge that in-home interoperability can impose is clear.

At first sight, guaranteeing interoperability could be requested from a CEM which could support a variety of communication technologies and protocols.

**Figure 2.** Flexibility functional architecture as proposed by the CEN-CENELEC-ETSI Smart Grid Coordination Group.

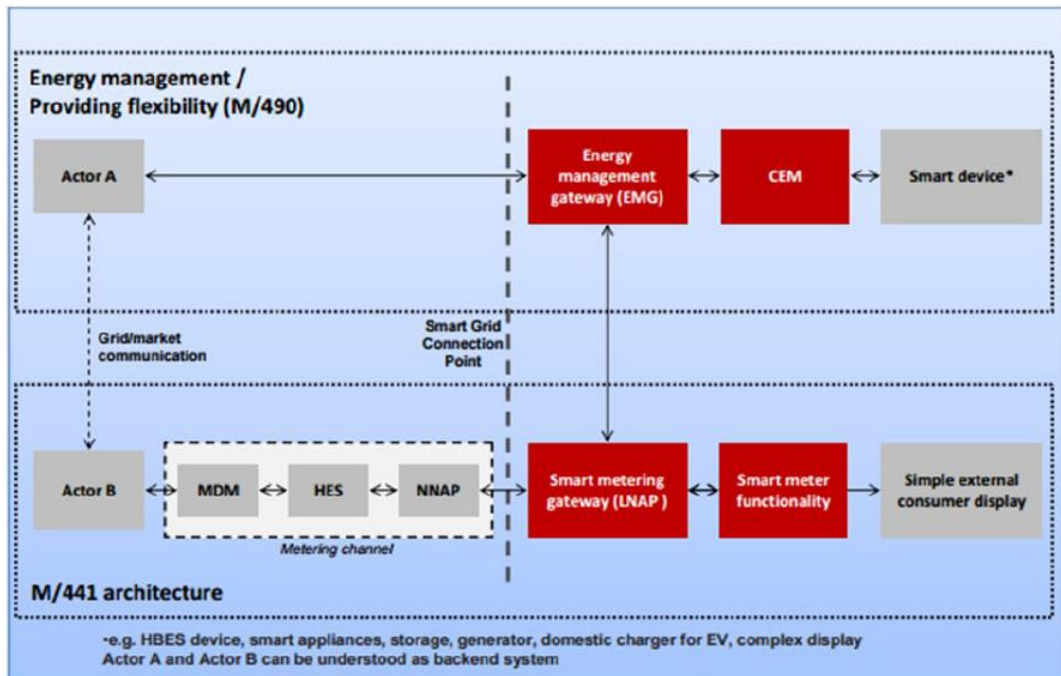

Source: (Delnooz, 2018), (Ectors, 2018).

**Figure 3.** Example of the complexity of the in home interoperability: variety of communication technologies and protocols.

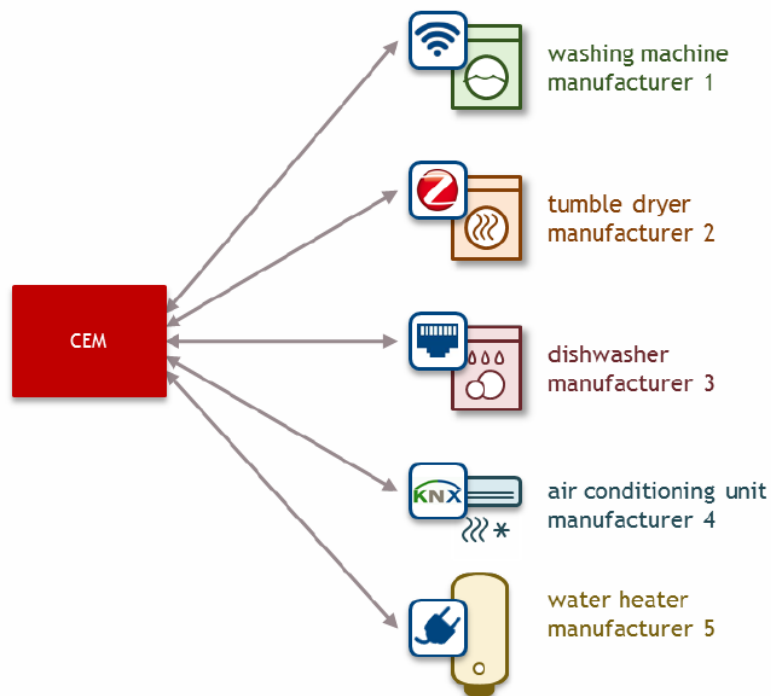

Source: (Ectors, 2018).

Furthermore, the Internet of Things (IoT) evolution shall be also taken into account in the above complexity, where the CEM shall adapt to this evolution and might be the case that provides IoT support for appliances interfaces made available via the internet as shown the following Figure 4. Illustration setups emerging from the combination of CEM and IoT technology.

**Figure 4.** Illustration setups emerging from the combination of CEM and IoT technology.

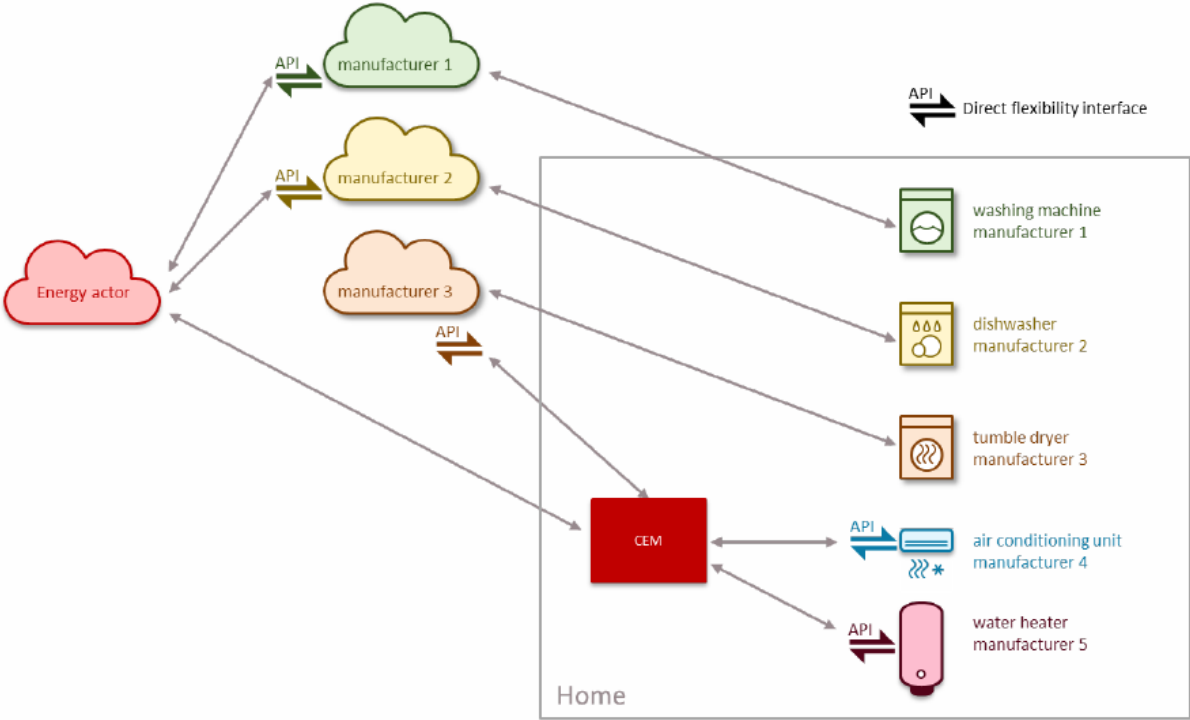

Source: (Ectors, 2018).

**3.3 Interconnect – Deliverable 1.2: Mapping between Use Cases and Large-scale Pilots**

Interconnect is a Horizon 2020 (H2020) project that entails 50 partners from 11 countries. Its scope is to develop solutions for connecting digitally smart homes and buildings with the electricity sector. The project involves seven pilot sites in different countries and among its objectives is to bring smart grid solutions to end users, whereas interoperability issues are also dealt with.

In the Deliverable D1.2: Mapping between Use Cases and Large-scale Pilots, (WP1 Pilot Partners - InterConnect, 2021), Interconnect is presenting the user centric system Use Cases (UCs) that will result in the description of the pilots of the project. For the purposes of this document we are going to review the energy smart appliances specific UCs (function UC) focusing mainly on the information exchange with the other actors.

**The French pilot:**

The French pilot is located in the metropolis of Toulon Provence Méditerranée and it involves 250 households, 20 public buildings and one school. The main objectives are to maximise locally produced energy and contribute in reducing costs of electricity consumption.

In the framework of the aforementioned objectives, the service provider enables customer to maximize the use of local renewable energy sources (RES) by automatically synchronizing with periods of high renewable production at the grid connection. In the High level Use Case (HLUC) "User appliances management" aims to minimize the cost of consumption by using energy smart appliances to consume during the best periods of the dynamic tariff. This use case will test how to synchronize the consumption of customer's appliances with the



period of best prices from the power supplier to minimize the electricity bill of the consumer in residential homes. There two main elements to be considered here regarding energy smart appliances:

- The white good is connected to the white good cloud and through the cloud to the interoperability layer.
- The devices (water heater, the heat pump, space heater and other devices) are connected through the energy management system (EMS) to the EMS cloud and then through this cloud to the interoperability layer.

The EMS is responsible to automatically actuate the appliances according to the recommendation from the smart orchestrator. Each EMS needs to send the actualized information to the smart orchestrator. The smart orchestrator modified its behaviour based on this feedback.

In this Pilot there is one more thing that is important and shall be taken into account: The customer remains at all time the master of any services and can cancel/stop any order that he wishes with the help of the graphic user Interfaces (GUI). The customer can disable the flexibility.

The following information is used in this pilot to maximize the usage of local RES and is relevant to the operation of the energy smart appliances/devices. These information is exchanged between different end points and the smart orchestrator. Therefore, we can classified this information using the entities involved.

#### Smart orchestrator:

- Provide a consumption schedule recommendation based on several criteria:
  - User preferences (permanent and ad-hoc rules).
  - Power profile of the appliance session.
  - Link data (permanent & real time data).
  - RES availability forecast (HLUC 1).
  - Dynamic tariff detail (HLUC 2).
  - Do not exceed subscribed power.
- Limit instantaneous power consumption.

#### EMS:

- Provides flexibility for the grid and execute the plan provided by the flexibility manager.
- Manage the appliance according to the smart orchestrator advices.
- Provides devices ad hoc rules to the smart orchestrator (if break business model, for the smart orchestrator to learn).
- Keep user comfort level: Charge EV according to user needs and keep heat and hot water close to user preferences.

#### GUI:

End-user will set up remotely/locally its preferences on different devices through a Graphic User Interface.

For the specific energy smart appliances the information is:

- Power profile exposure of the scheduled washing programs of each smart device. The washing machine can expose by cloud API to Living or Energy Manager which washing sequences are scheduled: start time, end time, number of slots/phases, slot duration, slot Power consumption, etc. Here below an example of power profile modelling.
- Load shifting command. Possibility to reschedule from the Living Service Manager or Energy Manager API the washing program sequence set by the end-user, such as changing the start time (anticipate or delay).

#### The smart devices:

- Are initiated by the user according to their preferences.
- Announce and request energy consumption according to own demand by possibly offering:

- Alternatives of power plans.
  - Adaptabilities.
- Inform about changes regarding energy consumption
- Allow:
- Flex shift of start time.
  - Selection of alternatives.
  - Pausing during cycle.

**Figure 5. French Pilot.**

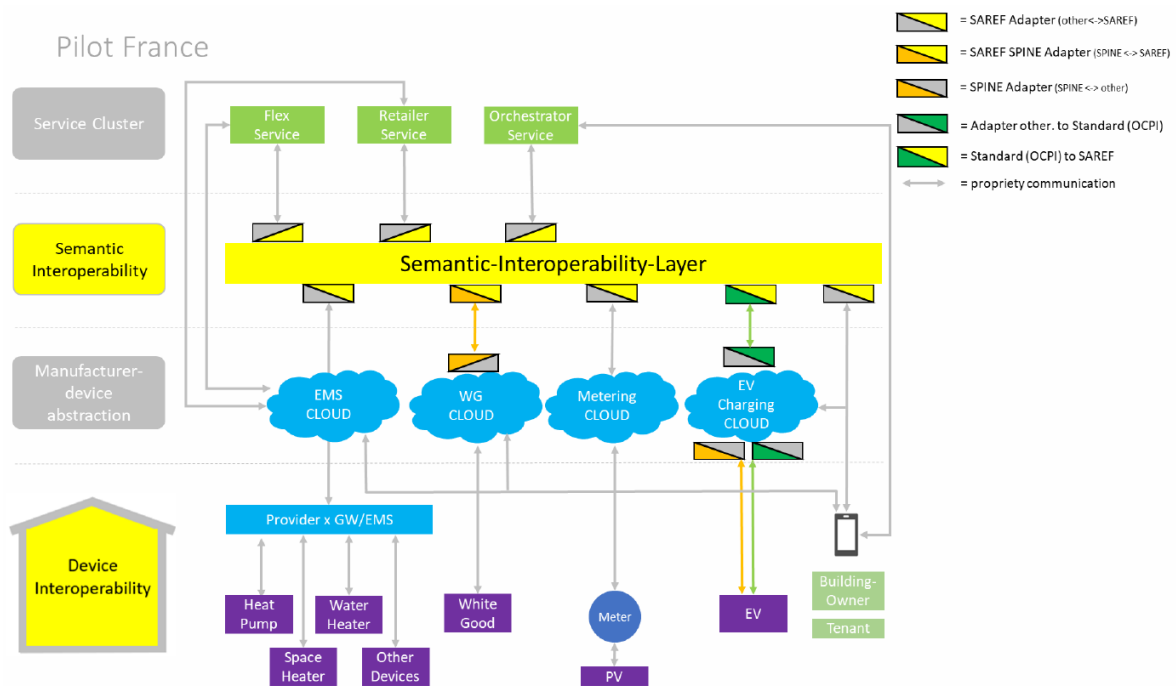

Source: (WP1 Pilot Partners - InterConnect, 2021).

### The German pilot:

In Germany there are two pilots: the Norderstedt and the Hamburg pilot. The first one aggregates prosumers in local energy community. The configuration in the local community of Norderstedt will mainly consist of premises equipped with:

- White goods appliances able to shift the start of power consumption.
- Heat pumps able to shift the start of and/or modulate power consumption.
- E-vehicles able to shift the start of and/or modulate power consumption.
- Energy manager which manages the orchestration.
- Application offering a dashboard for information exchange and preferences setting.

The Hamburg pilot is rather similar, so for the purposes of this document we will only be presenting the Norderstedt (see Figure 6).

The architecture here involves the EMS which connects and orchestrates the different devices or the devices are connected through their cloud to the interoperability layer. The EMS monitors all the smart devices and the user is able through a mobile app to check the devices. The EMS sends information about the PV generation power to devices to encourage them to use the self-generated energy and adapt their operation to it.

Here the energy smart appliances can exchange the following information:

- Exchange all relevant information with the pilot energy manager (PEM).
- Align and allocate power consumption details with PEM.

**Figure 6.** The German Pilot (Norderstedt).

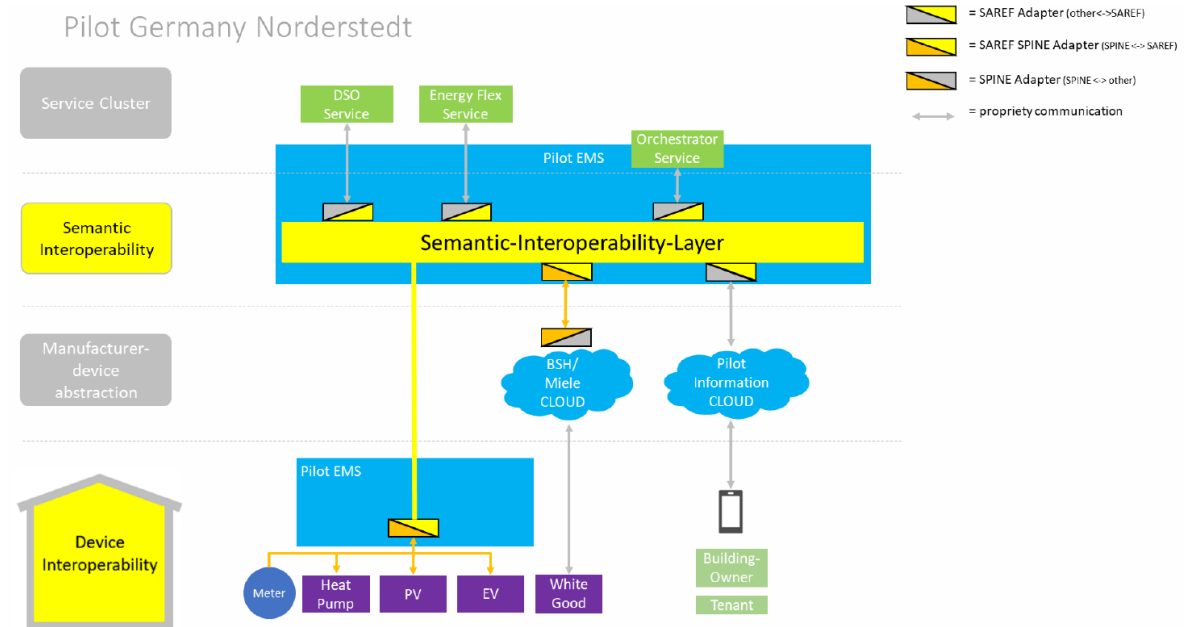

Source: (WP1 Pilot Partners - InterConnect, 2021).

**The Italian Pilot:**

One of the main objectives of the Italian pilot is to test an interoperable energy management system for residential dwellings, leveraging on different home appliances (type and manufacturer). User engagement will be fostered implementing gamified missions approaches within the digital services let available.

**Figure 7.** The Italian Pilot.

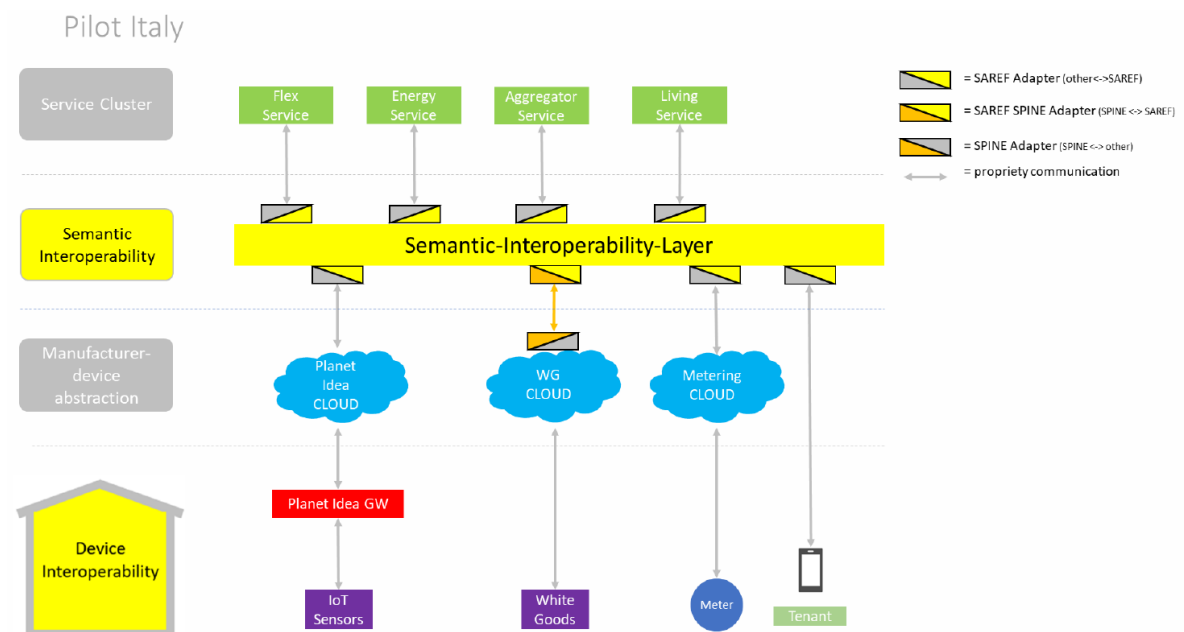

Source: (WP1 Pilot Partners - InterConnect, 2021).

The following interactions can be of our interest when we are discussing further of exchanged information from or to the energy smart appliances:

- The user has to provide consent about the data transfer from the device or manufacturer’s cloud to the energy manager. This is done by accessing the manufacturer’s App (application) and selecting in a specific section the possibility to share data with a third party chosen from a list. From this App, the request goes to the EM platform that responds with a request for confirmation. The Living Service Provider’s cloud sends the request for data sharing to the manufacturer’s cloud.
- User selects from the list of devices he has in the Energy Manager App those for which he wants to offer flexibility. Selection remains until removed by the user (the consensus may be revoked, specifically for a product on a certain day or time). User may provide limitations to cycle end time (e.g. no later than 7PM). The Living Service Provider will periodically check what products are available for energy flexibility by interrogating the App. The App provides the list of devices that are selected for flexibility and any limitation that is associated.
- Provision of meter data (power consumption) of bundled devices to an EM to create load and flexibility profiles (household consumption). Based on new load curves agreed upon with the Aggregator, the EM is able to control devices. In the end, a summary on total power that has been shifted is provided backwards from the EM platform to the Aggregator.
- The EM of the Energy Service providers aggregates all the flexible and non-flexible loads gathered from the end users periodically during the day. It then creates energy profiles over time for both the flexible and non-flexible loads. These profiles are provided, through the Living Service Provider, to the Aggregator who assesses the opportunity to offer incentives for shifting loads and so doing changes in the energy profiles.

**The Dutch pilot:**

The main objective in the Dutch pilot is to optimize the renewable energy use and operational efficiency of commercial and residential buildings, in combination with smart home based comfort services to the residents.

Figure 8. The Dutch Pilot

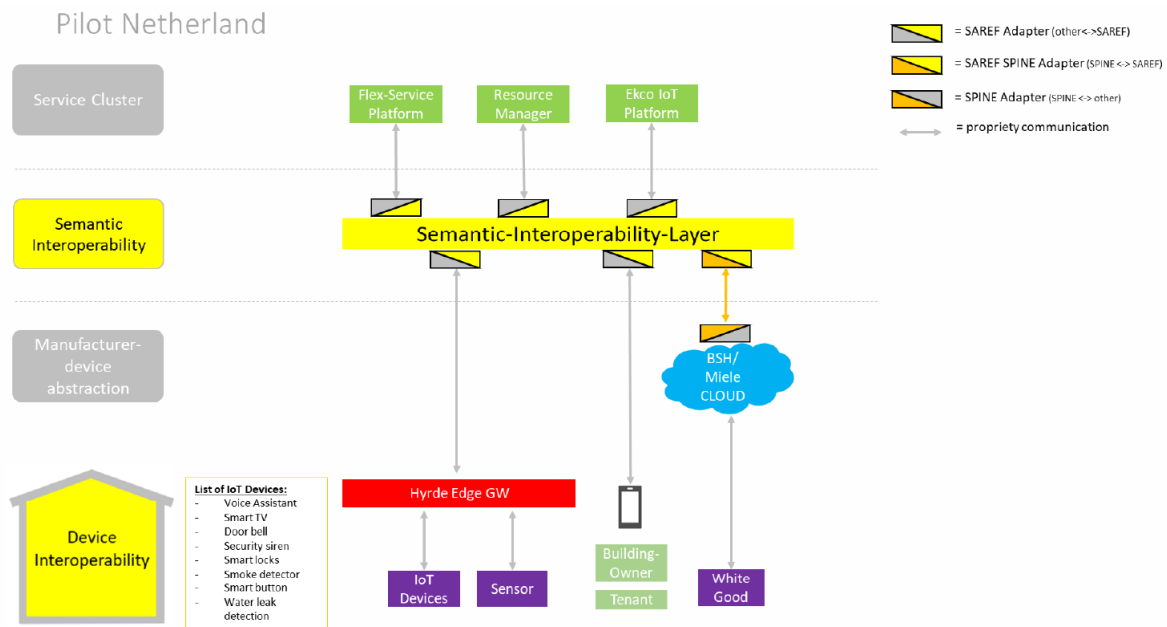

Source: (WP1 Pilot Partners - InterConnect, 2021).

For the Dutch pilot an interesting information sequence diagram which can be used in our project to tackle the main information exchange of smart devices can be seen below:

**Figure 9.** Sequence diagram of the Dutch Pilot.

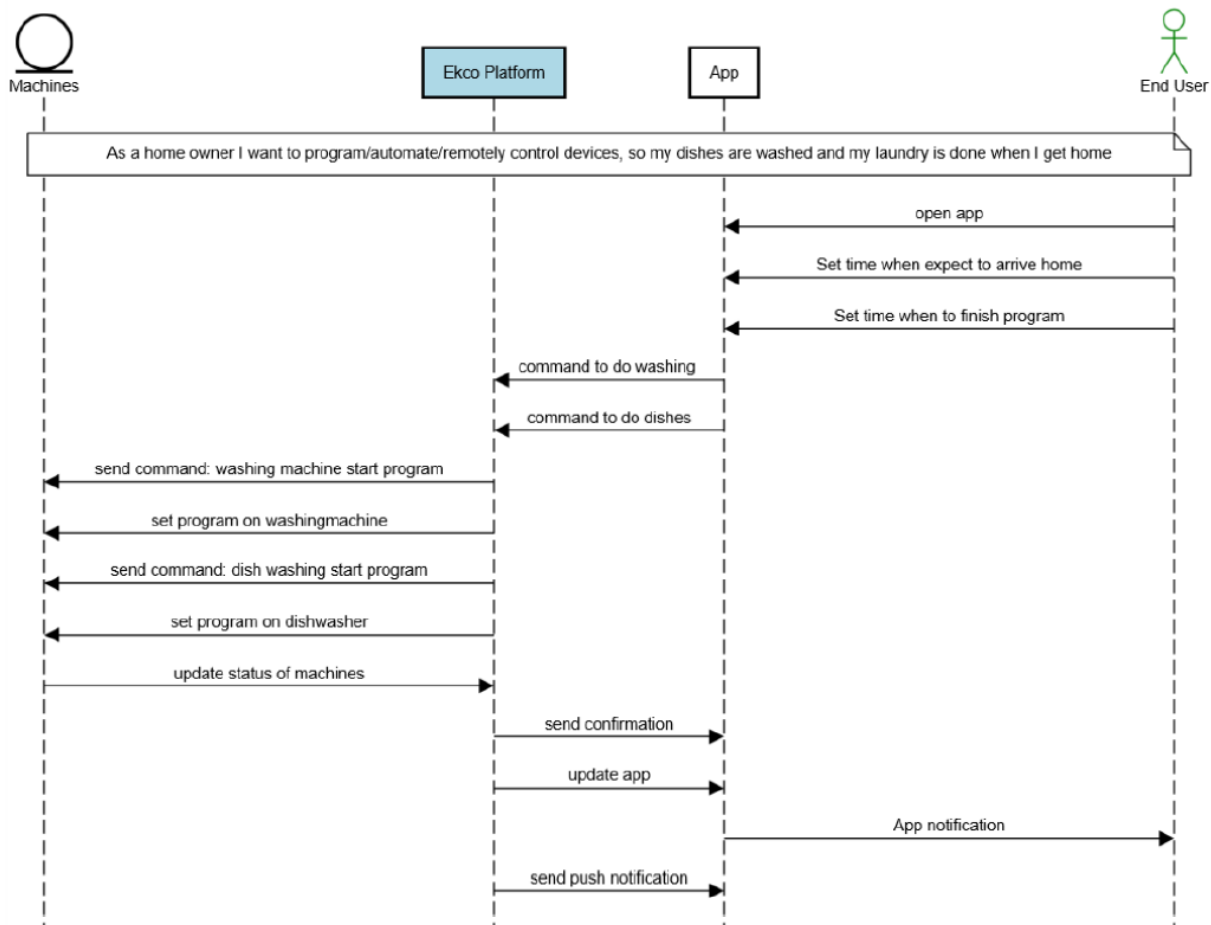

Source: (WP1 Pilot Partners - InterConnect, 2021).

The deliverable categorises in overall the services as following:

- Flexibility services.
- Grid stabilization service.
- Monitoring service.
- Comfort service.

The pilots presented in this deliverable are suggesting a cloud solution, thus the interoperability is realised mainly in this cloud. Only a few pilots, the German, Greek and Portuguese pilots, also realize local interoperability among devices to set up and run use cases and services requiring fast and reliable response (high time-sensitivity and infrastructural reliability). Those use cases that are less time-critical are located in the cloud.

The implementation and connection of the energy smart appliances is done through an interoperability layer which is basically the access point to the flexibility.

According to the report: the main task resulting from the interoperability lies in the development of a common adapter ontology. No matter if it proprietary to SPINE or SPINE to SAREF, the final adapters have to be aligned among all pilots to guarantee a seamless communication throughout all layers.

### 3.4 Interconnect - Deliverable 5.2: Data Flow Management

Beyond the ability of two or more systems to exchange information with correct syntax (i.e., grammatically correct), semantic understanding concerns the (automatic) correct interpretation of the meaning of information. To achieve semantic interoperability, at least two entities must refer to a common information exchange reference model. This reference model must define the meaning of the exchanged information (the words) in

detail. This is the only way to ensure that the communicating systems will correctly interpret the information and commands contained in the transferred data and will correctly act or react. Reference ontologies, such as SAREF, can be used to represent the common reference model. They may also model constraints about the information concepts by specifying assertions and inferences that can be used in reasoning mechanisms (e.g., if this, then that). This allows resolving interpretation conflicts in situations where two differently named classes in different models mean the same or when a class is a subset or superset of another class.

The proposed concept from the Interconnect project is a semantic interoperability layer as shown in Figure 10.

**Figure 10.** Interconnect Adapter: High level overview of the concept.

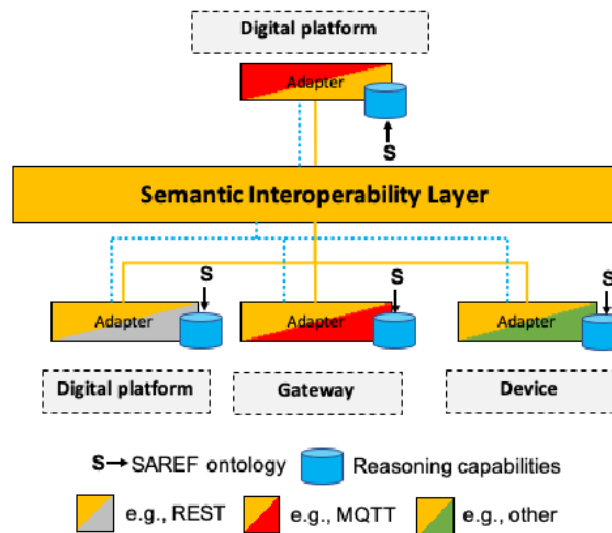

Source: (INESCTEC,VLF,TNO,TRIALOG - Interconnect, 2020).

### 3.5 European Smart Grids Task Force - Expert Group 1 – Standards and Interoperability

The European Commission had created Expert Groups, the so-called Smart Grid Task Force Expert Groups to address special topics of interest. One of these groups, namely the Expert Group 1 had dealt with the topic of Standards and Interoperability and produced a report dealing with services offered to end users for downloading their own consumption data. The final goal has been to improve the overall services offered by energy providers. One of the reports used here is the “My Energy Data”, as explained in the following.

#### 3.5.1 “My Energy Data” Report

In this report <sup>(10)</sup>, produced by the Expert Group 1 of the European Smart Grid Task force, two use cases related to My Energy Data (MED) services can be clustered into two groups, namely:

- Download my data.
- Share my data.

The Use Cases regard the data coming from smart meters and their implementation in the different Member States. Nevertheless, it interesting here to see to see the description of these two cases since there could be some commonalities with energy smart appliances respective ones:

MED – Download My Data Use cases:

- Authentication of request.

<sup>(10)</sup> European Smart Grids Task Force – Ad hoc group of the Expert Group 1 – Standards and Interoperability. 2016. My Energy Data. 2016. [https://ec.europa.eu/energy/sites/ener/files/documents/report\\_final\\_eg1\\_my\\_energy\\_data\\_15\\_november\\_2016.pdf](https://ec.europa.eu/energy/sites/ener/files/documents/report_final_eg1_my_energy_data_15_november_2016.pdf)

- Consent registry of request for download.
- Data provision.

MED – Share my Data Use cases:

- Authentication of request.
- Consent registry of request sharing.
- Data transmission.
- Provide the customer with all the information related to sharing my data on request.
- Provide erasure, restriction and rectification of personal data.
- Registry of the third party with the consent register process.

### **3.5.2 Towards Interoperability within the European Union for Electricity and Gas Data Access and Exchange**

The Group was asked to map national practices in the EU for data access and exchange, for both electricity and gas, and to reflect on available options or potential steps for making them interoperable. This deliverable <sup>(11)</sup> was meant to be a set of recommendations to advise the Commission on the scope and coverage of a potential EU secondary legislation on interoperability requirements and procedures for access and exchange of data within the EU. One of the main messages that came out from this report is that enabling interoperability brings specific requirements beyond the usage of existing standards. It shall define generic use cases with adapted role for the proper implementation of energy data download and the other services. More specific, some recommendations, that could be interesting to mention, are the following:

- Recommendation 4. Business requirements shall be the basis for interoperability and must remain technology-neutral.
- Recommendation 5. Adopt and use available European standards as a basis to improve interoperability.
- Recommendation 7. Specify information exchange in terms of exchange between harmonised roles.

For the meter data, the CIM (common information model) data elements are given as an example.

- Master data: consumer identifier, metering point identifier, and other optional data, such as, customer information, location information (customer, metering point).
- Meter data: metering point identifier, type of energy, metering interval, unit of measure, energy quantity (time series) and optional: quality indicators.

### **3.6 Public Available Specification (PAS) 1878:2021 Energy Smart Appliances – System Functionality and Architecture – This British Standard Institution (BSI)**

This British Standard (The British Standards Institution - PAS1878:2021) specifies requirements and criteria that an electrical appliance needs to meet in order to perform and be classified as an energy smart appliance (ESA). It defines the attributes, the functionalities and performance criteria for an ESA, and specifies how compliance with these can be verified.

For the purposes of the document, domestic and light commercial electrical appliances are termed as energy smart appliance when they:

1. Use a dedicated energy smart communications interface to:
  - (a) Provide status and forecast information concerning their energy use to other devices.
  - (b) Receive energy-related information and instructions from other devices.

---

<sup>(11)</sup> European Smart Grids Task Force Expert Group 1 – Standards and Interoperability Working Group on Data Format & Procedures. 2019. *Final Report - Towards Interoperability within the EU for Electricity and Gas Data Access & Exchange*. 2019. based on the findings of the EG1 Working Group "Electricity and Gas Data Format and Procedures". [https://ec.europa.eu/energy/sites/ener/files/documents/eg1\\_main\\_report\\_interop\\_data\\_access.pdf](https://ec.europa.eu/energy/sites/ener/files/documents/eg1_main_report_interop_data_access.pdf)

2. Meet the other requirements specified in this standard.

In this report interoperability is defined as the ability of an ESA to work seamlessly across any appropriate Demand Side Response (DSR) service operated by any authorized system actor. In order that DSR signals can be communicated to all ESAs, open standards to support interoperable commands and languages are essential for enabling free consumer choice, and thereby a competitive market. Communications to and from the ESA to the demand side response service provider (DSRSP) are necessary.

The key aspect of interoperability in this PAS is to allow a consumer to switch an ESA to a different DSRSP at any time and maintain DSR functionality without the need to purchase or install any new equipment, or the need for a home visit from an installer or supplier of equipment. This is supported by the definition of the minimum required common data model, information model and communication protocol, performance and security requirements for the interface between the DSRSP and CEM.

**Figure 11.** Representation of system level CEM-ESA energy flexibility architecture with separate CEM/ESAG.

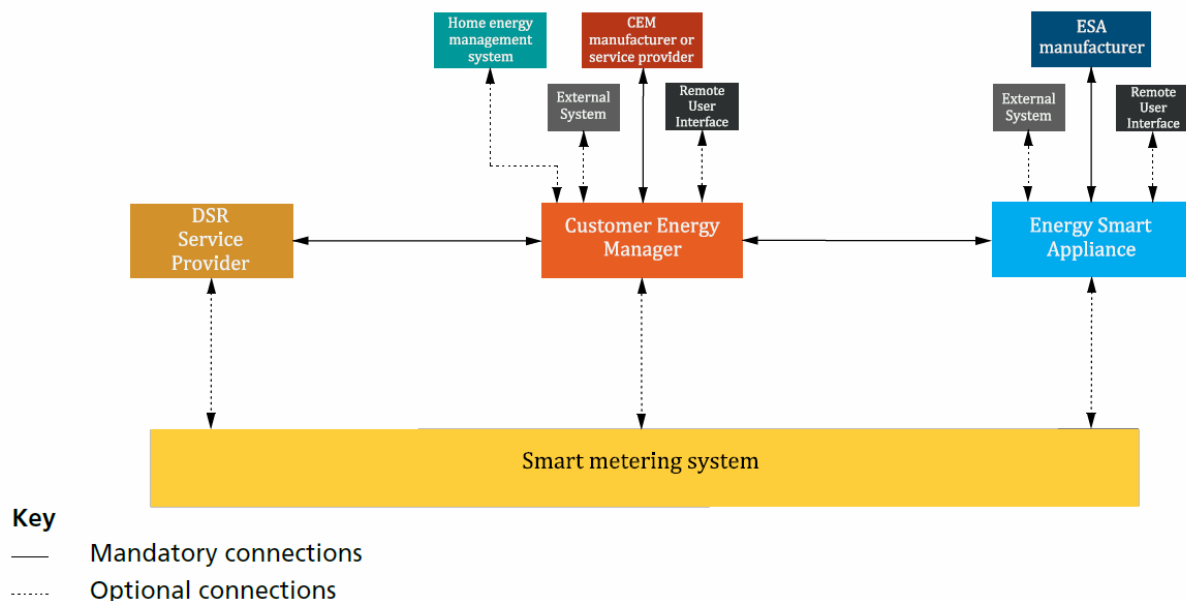

Source: (The British Standards Institution - PAS1878:2021).

The CEM and the ESA shall exchange information relating to device registration, de-registration, flexibility offers, DSR events, status, and cyber-security breaches between them. The following flow of information is defined:

1. Consumer registration with DSRSP.
2. CEM and ESA mutual authentication.
3. Device registration of the CEM and the ESA with the DSRSP.
4. Initialization.
5. Normal operation (four CEM operating modes).
6. Exception conditions.
7. De-registration.

### **3.7 Policy Guidance for Smart, Energy-Saving Consumer Devices - The Electronic Devices & Networks Annex (EDNA) of the International Energy Agency's (IEA) Energy Efficient End-Use Equipment (4E) Technology Collaboration Programme**

The document (Valdez, 2020) is addressing several barriers, particularly regarding the creation of a standardised approach to operating energy smart devices and how they interact. Many definitions, standards, and protocols exist for smart consumer devices and privacy, security, and interoperability issues may inhibit



market acceptance. Inappropriate use of these devices may also counter the ultimate goal of energy savings if smart devices use more energy to be 'smart' than the energy saved from intelligent efficiency and demand flexibility. Given the early stages of the smart consumer devices market, governments and international organisations are well-positioned to develop policies to help shape and incentivise this market, particularly focusing on energy savings and the issues of harmonisation, interoperability, security, and adoption of smart consumer devices. The report gives a good review of the definition of energy smart appliances in the US, EU and UK; summarized in Figure 12.

**Figure 12.** Summary of smart definitions.

|                               | Joint Stakeholder Petition to ENERGY STAR | ENERGY STAR | EU Ecodesign Preparatory Study on Smart Appliances | UK Consultation on Proposals Regarding Smart Appliances |
|-------------------------------|---|-------------|--|---|
| Demand Flexibility / Response | ✓   | ✓           | ✓  | ✓   |
| Status reporting              |   | ✓           |  |   |
| Open Communications Protocols |   | ✓           |  |   |

Source: (Valdez, 2020).

One of the challenges that the report is addressing is the interoperability issues. Lack of interoperability across platforms is a barrier that hinders adoption of smart, energy-saving devices. This is applicable to both interoperability amongst different connected devices as well as interoperability between devices in the consumer's home and various demand flexibility management platforms. If consumers have connected devices that are from several different brands and each brand has its own communication platform, it becomes increasingly difficult and cumbersome for consumers to learn and maintain communication across different platforms. It also limits consumers' ability to participate in different types of demand flexibility programs, if each program has its own communication platform which is not interoperable with other platforms. The issue of interoperability is not only an issue of communication between different types of platforms, but also an issue of the interpretation of commands on a central platform which communicates between different types of devices, known as semantic interoperability. For example, if a user sends a command via a central device manager to switch off certain devices, it is possible that the 'off' command may translate to different types of requests to different types of devices. Whereas the 'off' command could mean shutting off cooling for a smart Air Condition (AC), it could also mean activating a standby mode on a smart television. Although the interoperability problem refers to this point to platform level instead of device level, which is the focus of this report, it should be noted that lack of interoperability at platform level, means lack of interoperability for the end devices. Thus, it is indirectly a problem for devices.

Based on the report, interoperability challenges can be addressed by promoting and utilizing open protocols. While some manufacturers may prefer closed or proprietary platforms, this approach would generally be a hindrance to consumers. One potential approach to address this would be to have smart hubs that can communicate across different platforms with connected devices, and operate as a central, single hub for consumer communication with all devices as well as with the grid. Additionally, open communication protocols can be beneficial to manufacturers as well because it allows them to provide their services through multiple platforms and application stores without significant development costs.

Lastly, to alleviate the issues caused by semantic interoperability, communication protocol standards can define a single core information model which every device must comply with. This core information model defines commands which a user can request. Individual manufacturers must design the actions of a device according to each type of command.

### **3.8 Are we getting the best out of Smart Home Technologies? The Role of Usability – Energy Efficient End-Use Equipment – Electronic Devices and Networks Annex – Use Centred Energy Systems**

The EDNA Annex (Electronic Devices and Networks Annex) of 4E (Energy Efficient End-Use Equipment) has these same aims but is focussed on a horizontal subset of energy using equipment and systems – those which are able to be connected via a communications network. The objective of EDNA is to provide technical analysis and policy guidance to members and other governments aimed at improving the energy efficiency of connected devices and the systems in which they operate.

EDNA is focussed on the energy consumption of network connected devices, on the increased energy consumption that results from devices becoming network connected, and on system energy efficiency: the optimal operation of systems of devices to save energy (aka “intelligent efficiency”) including providing other energy benefits such as demand response.

From the EDNA perspective, devices are key components of any system, and thus the entrée to examining energy aspects of systems as well as the phenomenon of the digitalisation of systems. Systems can include buildings, energy grids and communications networks.

Specifically, the report <sup>(12)</sup> on the role of usability has been published in October 2021 and it is a review to understand the extent to which poor usability of smart home technologies (SHT), at set up and operation, is contributing to this problem.

The findings of the report suggest an absence of evidence. Most notable the anticipated issue of interoperability is rarely reported. Finally, the report consolidates a number of recommendations:

- Encourage business to create usable, holistic solutions.
- Develop shared infrastructures to help speed up understanding of usability issues in the energy sector.
- Governments should design markets that flow the value of increased flexibility to the right place in the system, including the demand side.
- Don’t wait for usability issues to emerge, actively seek to uncover them now. The development of shared learning infrastructures can help speed this up.
- Invest in innovation to help the sector understand how to deliver positive and engaging user experiences.

Some of the main points from the document can be summarised below:

- Users are increasingly mindful about how their data are being used. This means that even if different areas of the energy sector are willing to collaborate, they still need to find a way to convince the user to share their details, or crucial data may not be readily provided.
- Automation is thought to hold the key to better usability and smart system optimisation, but it is not yet at the level required. Automation can support users by reducing the burden of decision making whilst simultaneously seeking to optimise how the system operates.
- Household conditions are variable, but this isn’t always considered during product development. Products are often developed and tested in (optimal) laboratory settings. If similar “perfect” conditions are assumed for the homes in which they are deployed, issues can arise.
- Interoperability has been addressed here as an issue that is rarely encountered. Interoperability is the ability of a system or component to function effectively with other systems or components. One of the ambitions of this review was to understand whether proprietary systems were a contributor to poor usability. A home that incorporates many different smart technologies, for example, may cause the user issues if the different technologies cannot work together seamlessly. As previously discussed, the academic nature of the evidence identified has meant usability issues arising from lack of interoperability are rarely discussed. Broadly, this is because experiments often take place in laboratory conditions or technologies were installed, and sometimes developed, by those conducting the research, i.e. prototypes. This meant that users did not have to attempt to incorporate the technologies into their home ecosystems themselves as this had

---

<sup>(12)</sup> Are we getting the best out of smart home technologies? The role of Usability 4E-Electronic and Networks Annex EDNA – Use Centred Energy systems, 2021, <https://www.iea-4e.org/wp-content/uploads/2021/10/Usability-Report-Final.pdf>

already been addressed on their behalf. Despite a lack of evidence in the sources evaluated, interoperability was commonly cited as being crucial to the success of SHTs.

- As uptake of SHTs increases, it is likely issues owing to lack of interoperability will also grow. An increase in the variety of SHTs available, and the manufacturers who develop them, will likely mean a broader (and potentially more complex) range of functionality will be offered to users. If brands are reluctant to conform or offer interoperability (as has been suggested in the expert interviews), the issue of interoperability is likely to become a much greater issue. This however will not happen until later in the SHT adoption curve.

Finally, the report suggests to be prepared for the challenge of interoperability.

- Integration of smart technologies into people's homes will naturally happen in increments, rather than all at once. It is therefore important to respect existing technological arrangements at every stage of the process to preserve experience.
- Some specific features/functionality offered by SHTs are expected to be better received as part of a broader application. For example, controls to operate smart lighting may be better received as a sub-feature of a broader whole home application, rather than requiring its own application. Consolidation effectively lessens the demand on the user, as it means they only have to master one control system.

### 3.9 Summary

In this Chapter we have performed a thorough literature review of reports/ sources that deal with interoperability in smart appliances. We have presented their main findings related to the topic and highlighted issues that are important for achieving interoperability among smart appliances. The list of reports used for this literature review is as follows:

1. First Phase of the *Ecodesign Preparatory Study on Smart Appliances (Lot 33): Methodology for Ecodesign of Energy-related Products (MEErP) Tasks 1-6*
2. Second Phase of the *Ecodesign Preparatory Study on Smart Appliances (Lot 33): Methodology for Ecodesign of Energy-related Products (MEErP) Task 7*
3. Interconnect – Deliverable 1.2: Mapping between Use Cases and Large-scale Pilots
4. Interconnect - Deliverable 5.2: Data Flow Management
5. European Smart Grids Task Force - Expert Group 1 – Standards and Interoperability
6. Public Available Specification (PAS) 1878:2021 Energy Smart Appliances – System Functionality and Architecture – This British Standard Institution (BSI)
7. Policy Guidance for Smart, Energy-Saving Consumer Devices - The Electronic Devices & Networks Annex (EDNA) of the International Energy Agency's (IEA) Energy Efficient End-Use Equipment (4E) Technology Collaboration Programme
8. Are we getting the best out of Smart Home Technologies? The Role of Usability -- Energy Efficient End-Use Equipment 4E- - Electronic Devices and Networks Annex EDNA – Use Centred Energy Systems

In the following, we move on with the description of Use Cases on smart appliances and the definition of principles for data exchange.

## 4 Use Cases for Energy Smart Appliances

In the previous chapters we have analysed the main reports which are tackling the issue of interoperability in energy smart appliances. There are more documents and websites that have been reviewed during this exercise like the California legislation on energy smart appliances <sup>(13)</sup>, the Energy Star Initiative <sup>(14)</sup>, documents from industrial associations like APPLiA – Home Appliance Europe <sup>(15)</sup>, Smart Grid Read heat pumps <sup>(16)</sup>, the BRIDGE Initiative and especially its dedicated Working Group on Data Management <sup>(17)</sup> and many more.

As energy smart appliances attract more and more interest in the scientific community, it becomes necessary to develop Use Cases and check the interactions among important actors with respect to the appliances. Based on these interactions, useful conclusions can be drawn with respect to requirements for data exchange and sharing; in addition, gaps can be identified regarding areas that need further investigation on energy smart appliances and the actors playing key role in interactions with them.

However, as the number of energy smart appliances grows, so does the number of use cases that can be developed. This number becomes even higher when considering the number of interested actors that could interact with them, like consumers, DSOs, energy providers, aggregators from the entity point of view, and also home energy management systems, gateways, smart applications, etc.; from software and hardware point of view. The use cases to be developed get to vary also depending on the applications that are examined and in case these applications are consumer centric or higher level centric (aggregator, DSO, etc.). They can be also distinguished from a technical point of view, like successfulness of establishing a communication link or transmitting final messages to consumers, but also from a non-technical point of view, like for example achieving market objectives, participating in the day-ahead or the imbalance market.

It becomes obvious that the number of use cases involving energy smart appliances can be seriously high and not every use case can be presented and analysed in a sole report. However, it is important to present the basics with respect to the use cases on such appliances, demonstrate the main actors and their interactions. This gives the guidelines for developing such use cases and also present practical examples involving energy smart appliances. This is the scope of this chapter. The analysis of the use cases is presented in the Annex 1 and in the following chapters the main messages from this analysis are presented.

### 4.1 Generic Use Cases on Energy Smart Appliances based on the Existence or Absence of a Gateway

First of all, we present two generic use cases with energy smart appliances based on the distinction presented in one of the previous chapters, which has to do with the communication between these appliances and the energy service provider. As it has been discussed, energy smart appliances can communicate with the energy service provider directly through a cloud model, or they can communicate through a gateway, which can be situated within the house or not. In the first scenario, several links need to be established between the energy smart appliances and the energy provider, whereas in the second scenario, only one link is needed between the energy provider and the gateway, with multiple links present between this gateway and the energy smart appliances.

Two generic simple use cases are presented in Figure 13. The relevant actors are the energy smart appliances themselves, the energy gateway, and the energy service provider. In a first use case, the energy smart appliances communicate with the energy gateway and this in turn communicates with the energy service provider. In a second use case, the energy smart appliances communicate directly through the cloud with the energy service provider. See, respectively, diagrams represented in a) and b) of the figure.

---

<sup>(13)</sup> Steffensen, Sean. 2020. *Introduction to Flexible Demand Appliance Standards*. California Energy Commission. California Legislative Information. Publication Number: CEC-400-2020-013. <https://efiling.energy.ca.gov/GetDocument.aspx?tn=235899> and/or <https://www.energy.ca.gov/proceedings/energy-commission-proceedings/flexible-demand-appliances>

<sup>(14)</sup> [https://www.energystar.gov/products/spec/smart\\_home\\_energy\\_management\\_systems\\_pd](https://www.energystar.gov/products/spec/smart_home_energy_management_systems_pd) and/or <https://www.energystar.gov/>

<sup>(15)</sup> <https://www.applia-europe.eu/>

<sup>(16)</sup> <https://www.waermepumpe.de/normen-technik/sq-ready/>

<sup>(17)</sup> <https://bridge-smart-grid-storage-systems-digital-projects.ec.europa.eu/working-groups/data-management>

**Figure 13.** Message sequence chart for generic Use Case, a) Communication of energy smart appliances through the home energy gateway, b) Communication of energy smart appliances directly to the energy service provider through the cloud.

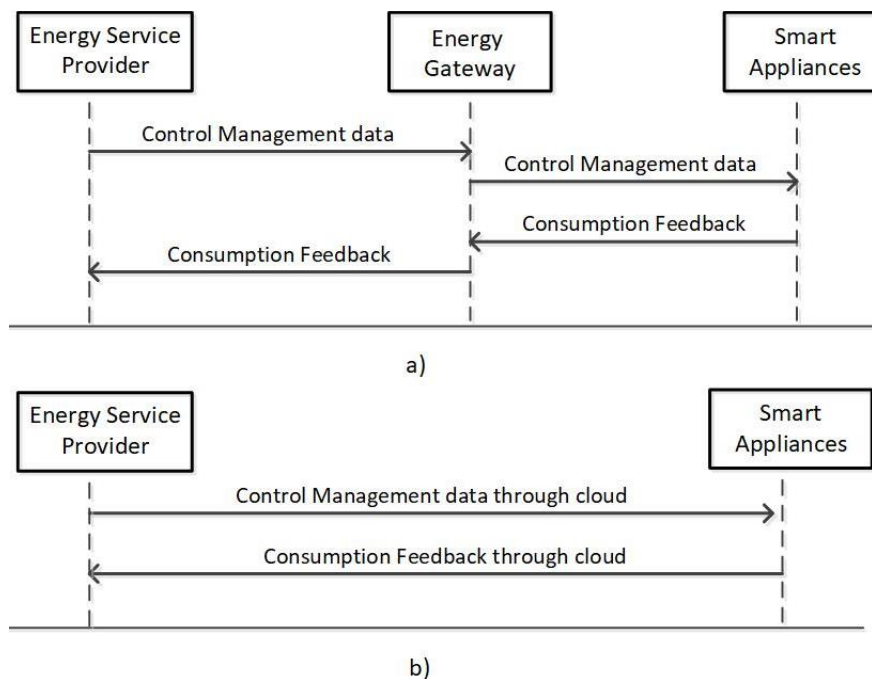

Source: JRC analysis, 2022.

## 4.2 Representation of Use Cases on Energy Smart Appliances based on the *Ecodesign Preparatory study on Smart Appliances, Task 7*

The *Ecodesign Preparatory study on smart appliances* has worked in detail on energy smart appliances and their role in the smart grid and has published two reports, referred as *Task 1-6* (Delnooz, 2018) and *Task 7* (Ectors, 2018). The latter one categorizes the Use Cases according to their interaction with external actors, or the lack of it, and according to whether or not the Use Case takes place at user premises. In the following, we discuss about these generic categories and present the Use Cases under each one of them in Annex, where we present the message sequence charts for the generic representation of the use cases as well as the ones regarding each Use Case described in the *Task 7* report. The added value here is that such message sequence charts are presented, which help in defining the principles of data exchange. The categories presented, are:

- Explicit Demand Response Use Cases.
- Implicit Demand Response Use Cases.
- Local optimal energy consumption Use Cases.
- Standalone Demand Response Use Cases.

The last two categories have to do with Use Cases that take place at consumer premises, whereas the first two involve an external actor. The latter, either takes direct control of energy smart appliances (first option) or sends information of price signals and allows for a local control of the energy smart appliances at consumer premises (second option).

### 4.2.1 Explicit Demand Response Use Cases

In this Section, we analyse the generic Use Case on Energy Smart Appliances that is described in the *Ecodesign Preparatory study on Smart Appliances (Lot 33), Task 7 Report – Policy and Scenario Analysis* related to explicit Demand Response. Such Use Cases deal with the energy smart appliances that are allowed to be controlled by an external party (DSO, aggregator, Energy Company, etc.). The flexibility status of such appliance is communicated to this external party, which subsequently turns on and off the smart appliance according to the needs of the system. Comfort boundaries are also taken into account, which are usually set by the end user. Figure 14 presents the Message Sequence Chart for such a generic Use Case.

**Figure 14.** Message Sequence Chart for the generic Use Case of explicit demand response.

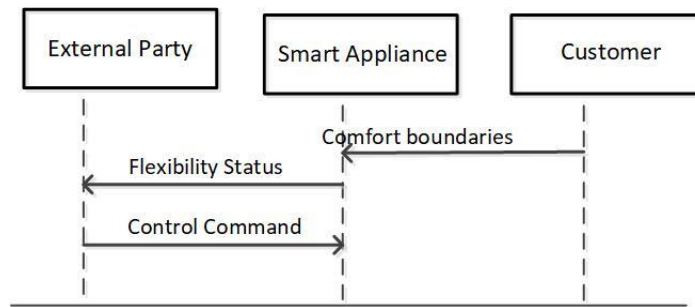

Source: JRC analysis, 2022.

#### 4.2.2 Implicit Demand Response Use Cases

In this Section, we analyse the Use Case on Smart Appliances that is described in the *Ecodesign Preparatory study on Smart Appliances (Lot 33), Task 7 Report – Policy and Scenario Analysis* related to implicit Demand Response. In this category of Use Cases, the energy smart appliances receive price/ tariff information by an external party (DSO, aggregator, Energy Company, etc.) and subsequently decide to alter consumption or production, so as to minimize energy consumption or maximize electricity production fee. Figure 15 gives the Message Sequence Chart for this generic Use Case on implicit demand response.

**Figure 15.** Message Sequence Chart for the generic use case of implicit demand response.

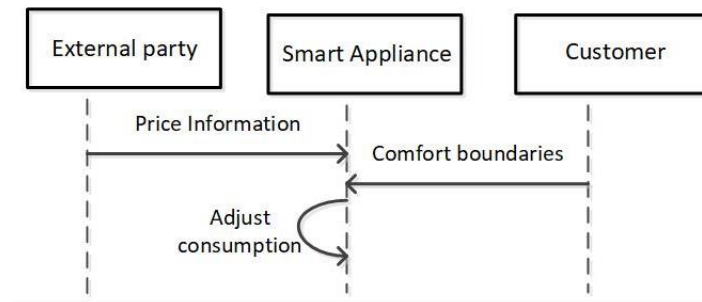

Source: JRC analysis, 2022.

In the Annex, we give a description of each Use Case falling in this category. We firstly give a short description of each Use Case, as this is found in this Task and we give its representation in the equivalent Message Sequence Charts. These Message Sequence Charts give a graphical representation of the actors involved and the information exchanged.

#### 4.2.3 Local Optimal Energy Consumption Use Cases

In this Section, we analyse the generic Use Case on Smart Appliances that is described in the *Ecodesign Preparatory study on Smart Appliances (Lot 33), Task 7 Report – Policy and Scenario Analysis* (Ectors, 2018) related to local optimal energy consumption. In this category of Use Cases, everything takes place at the consumer’s premises. The key point here is a local controller, which has access to energy production data (i.e. from PVs) and also consumption data (i.e. from smart meters). So, it decides when it is best to turn on and off the energy smart appliances within the house based on the above information. These appliances communicate with the controller by sending their flexibility status. The Message Sequence Chart for this generic Use Case is shown in Figure 16.

**Figure 16.** Message Sequence Chart for the generic use case of local optimal energy consumption.

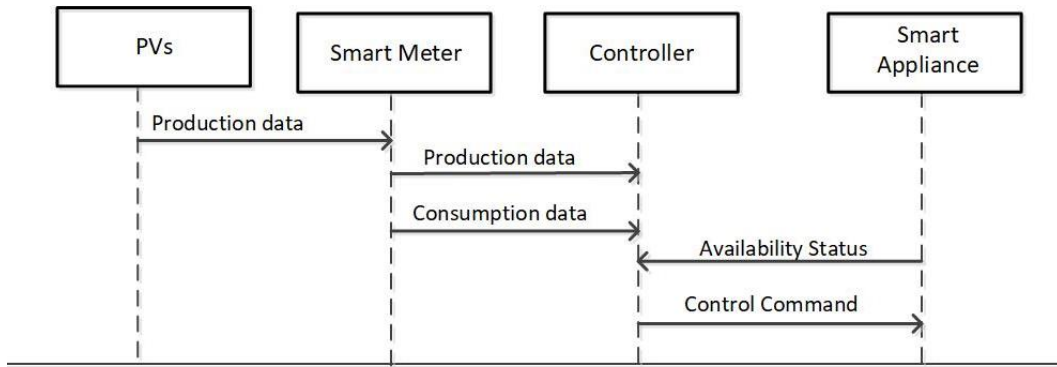

Source: JRC analysis, 2022.

#### 4.2.4 Standalone Demand Response Use Cases

In this Section, we analyse the generic Use Case on Smart Appliances that is described in the *Ecodesign Preparatory study on Smart Appliances (Lot 33), Task 7 Report – Policy and Scenario Analysis* related to standalone demand response use cases. In this category of Use Cases, everything takes place within the smart appliance. It is able to measure specific grid parameters, like voltage and frequency. When one of them exceeds a specific value, it regulates the consumption so as to benefit the grid. The message sequence charts that describes this generic Use case is shown in Figure 17.

**Figure 17.** Message Sequence Chart for the generic Use Case of Standalone demand response.

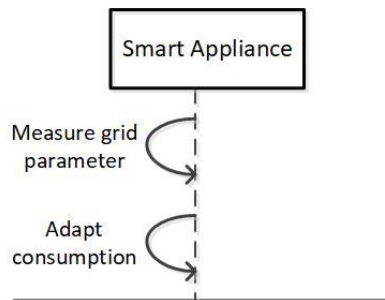

Source: JRC analysis, 2022.

All the Use Cases on which this analysis is based, are presented and analysed in the Annex 1. The four UC cases studied in sections, 254.2.1, 4.2.2, 4.2.3, and 4.2.4, based on the *Ecodesign Preparatory study on Smart Appliances, Task 7*, are described using the Smart Appliance Reference or SAREF interoperability language in Annex 2. This latter annex contains information of the extension SAREF4Ener<sup>(18)</sup> as well, which is an extension of SAREF for the electricity domain.

<sup>(18)</sup> SAREF4ENER is an extension of SAREF for the energy domain created in collaboration with [Energy@Home](https://energyat-home.eu/) and [EEBUS](https://eebus.eu/) associations. <https://saref.etsi.org/saref4ener/v1.1.2/>.

## 5 Principles of the Information Exchange of Energy Smart Appliances with their Ecosystem

In most of the documents we identify that the best practice is initially to describe the Use Cases of energy smart appliances and based on this to define the communication and information exchanges. The architecture of the system needs to be defined first and that includes the actors that take part in the specific functionality that is described. Then the information exchange between the actors can be drawn. In this way, we understand what the main interactions of a smart appliance are with the rest of the ecosystem:

- With whom the appliance is exchanging information (actors).
- What is the specific information that the energy smart appliance will exchange in order to execute the functionality of the specific Use Case (information).

There are many Use Cases to be found in the literature reviewed in the previous chapters and many similarities between these Use Cases. Sometimes it is only some definitions that are different in the reports. One of our tasks was through the literature review to consolidate the basic Use Cases (generic) and analyse them in a way so that the information exchange can be defined. Our main focus is the information that the smart appliance is exchanging with another actor, if this actor is called for example EMS or orchestrator is out of the scope of this document to define. In this way we try to remain as more as possible architectural and technological neutral.

### 5.1 Actors Interacting with Energy Smart Appliances

Based on the Use Cases analysed, we have grouped the actors (herein Actor B), considering with which the energy smart appliances are interacting (Table 2), into four main categories of actors.

**Table 2.** Actors interacting with energy smart appliances.

| Actor A                | Actor B                                  | Terminology used for Actor B   |
|------------------------|--|--|
| Energy smart appliance | Device within house for control purposes | Home Energy Gateway, Home Gateway, Grid Appliance Controller, Home Energy Controller, Energy Management System (EMS), Central EMS, Building Acquisition Control System (BACS). |
| Energy smart appliance | Energy service provider                  | Energy Service Provider, Energy Company, Market Energy Company, Power System, DSO  |
| Energy smart appliance | Customer                                 | Customer, flexibility owner  |
| Energy smart appliance | Device outside house                     | Linear Pilot Backend, Signal Receiver, VPP – intelligent load manager, Smart Charging App, Linear Portal, smart storage system, smart App, smart orchestrator, platform        |

Source: JRC analysis, 2022.

Table 2 is the consolidation of the 36 Use Cases that we have analysed (more details can be found in the Annex 1 and 3) and led us to the conclusion that energy smart appliances are mainly interacting with four actors. Table 3 summarises the analysis of the UCs found in Annex 2. It should also be noticed here, that some UCs do not refer explicitly to interactions between energy smart appliances and other actors, thus the equivalent slots in the table are blank.



**Table 3.** Interactions of energy smart appliances with other actors based on the analysed Use Cases.

| n. | UCs  | 1. SA <-> Device within home for control purposes (i.e. Home Energy Gateway, EMS, etc.) | 2. SA <-> Energy Service Provider (through cloud) | 3. SA <-> Customer | 4. SA <-> control point outside the house, owned / controlled by service provider |
|----|--|---|---|--------------------|---|
|    | <b>Ecodesign – Task 7 UCs – Explicit DR</b>                      |   |   |                    |   |
| 1  | UC 1 – Belgium (Flemish Region)                                  |   |   |                    | Yes   |
| 2  | UC 2 – Australia (South East Queensland)                         |   |   | Yes                | Yes   |
| 3  | UC3 – Germany  | Yes   |   |                    |   |
| 4  | UC4 – United States (Austin)                                     |   | Yes   | Yes                |   |
| 5  | UC5 – United States (California)                                 |   |   |                    | Yes   |
|    | <b>Ecodesign – Task 7 UCs – Implicit DR</b>                      |   |   |                    |   |
| 6  | UC1 – Belgium (Flemish region)                                   |   | Yes   | Yes                |   |
| 7  | UC2 – Germany (Cuxhaven Region – Lower Saxony)                   |   |   |                    |   |
| 8  | UC3 – Netherlands  |   |   |                    | Yes   |
|    | <b>Ecodesign – Task 7 UCs – Local optimal energy consumption</b> |   |   |                    |   |
| 9  | UC 1 – Germany (Cuxhaven Region – Lower Saxony)                  |   |   |                    | Yes   |
| 10 | UC 2 – United States   |   |   |                    | Yes   |
|    | <b>Ecodesign – Task 7 UCs – Standalone DR</b>                    |   |   |                    |   |
| 11 | UC 1 – Belgium (Flemish region)                                  | Yes   |   |                    |   |
| 12 | UC 2 – United States (Pacific Northwest)                         | Yes   |   |                    |   |
|    | <b>Ecodesign – Tasks 1-6 UCs</b>                                 |   |   |                    |   |
| 13 | UC 1 – Load shifting of heat pump supplied houses                | Yes   |   |                    |   |

|    |  |     |     |     |     |
|----|--|-----|-----|-----|-----|
| 14 | UC 2 - Self-consumption of on-site produced RES energy   | Yes |     |     |     |
| 15 | UC 3 - Variable pricing support by a washing machine   |     | Yes | Yes |     |
| 16 | UC 4 - Appliance-based system frequency control of freezers  |     | Yes |     |     |
| 17 | UC 5 - Distribution grid congestion management by buffered water heaters   |     | Yes |     |     |
| 18 | UC 6 - Frequency restoration reserves based on commercial refrigeration  | Yes |     |     |     |
| 19 | UC 7 - Peak shaving combined with energy efficiency by appliances controlled by a building automation and control system | Yes |     |     |     |
|    | <b>Interconnect project UCs – French pilot site</b>  |     |     |     |     |
| 20 | PUC1 - Production PV   |     |     |     |     |
| 21 | PUC2 – Setup of the end user preferences   | Yes |     |     |     |
| 22 | PUC3 – Provide a contract to the customer  |     |     |     |     |
| 23 | PUC4 – EMS processing and operations   | Yes |     |     |     |
| 24 | PUC5 – Smart Orchestrator Processing and Operations  | Yes |     |     |     |
| 25 | PUC6 – The end-user takes the control  |     |     | Yes |     |
| 26 | PUC7 – Provide Dynamic Tariff to the end-user  |     |     |     |     |
| 27 | PUC8 – Providing Dynamic Tariff  |     |     |     | Yes |
| 28 | PUC9 – Providing Flexibility   |     |     | Yes |     |
| 29 | HLUC1 – Maximize the Use of Local RES  | Yes |     |     |     |

|    |   |     |     |     |     |
|----|---|-----|-----|-----|-----|
| 30 | HLUC2 – Dynamic Tariff and Usage Management                   | Yes |     |     |     |
|    | <b>Interconnect project UCs – Dutch pilot site</b>            |     |     |     |     |
| 31 | UC1 – Devices that can be controlled to free up time          |     |     |     | Yes |
| 32 | UC2 – Information Control                                     |     | Yes |     | Yes |
|    | <b>E@Home Technical Specification UCs</b>                     |     |     |     |     |
| 33 | UC1 – Visualization of consumption and price data             | Yes |     | Yes |     |
| 34 | UC2 – Setting of a smart appliance according to price tariffs | Yes |     | Yes |     |
| 35 | UC3 – Control of smart appliance in case of overload          | Yes |     | Yes |     |
| 36 | UC4 – Interaction of smart meter                              | Yes |     |     |     |

Source: JRC analysis, 2022.

## 5.2 Information Exchange of Energy Smart Appliances

As it is already defined in (Delnooz, 2018), smart appliance is an appliance that:

- It is able to automatically respond to external stimuli e.g. price information, direct control signals, and/or local measurements (mainly voltage and frequency).
- It is able to change its electricity consumption pattern. These changes to the consumption pattern is what we call the ‘flexibility’ of the smart appliance.

Flexibility’ is the response to an external stimulus in form of a change of an appliance’s electricity consumption pattern. Flexibility is defined by two parameters.

- A shifting potential ( $E_f$ ): the average amount of energy per appliance that can be shifted, expressed as a time series per hour in function of the time of day in [kWh/h]. There are  $24E_f$  values.
- A shifting period ( $T_f$ ): the average number of hours [h] the appliance’s consumption can be shifted (i.e., to consume later/earlier in time than initially planned).

Where the total flexibility ( $F$ ) can be quantified as  $F = T_f \sum_i E_f i$ .

Many of the reports reviewed, like the BSI (The British Standards Institution - PAS1878:2021) have determined what is the information exchange during several operations of the energy smart appliance, for example the smart appliance can send signals related to:

- Its current flexibility offers.
- Any current flexibility offer updates.
- Updated profile as an act upon a request to implement a flexibility offer.
- Indication that it is operating in a DSR event period using its user interface.

- Periodical report its instantaneous power consumption to the interacting actor during a DSR event, or log its power consumption during a DSR event and report this as an actual power profile at the end of the DSR event.
- Acknowledgement for each accepted flexibility offer request to the DSRSP.
- Indication to the interacting actor that it has cancelled the previously selected flexibility offer.

When the energy smart appliance accepts a response offer from an actor B then it shall send an acknowledgement information and start operating according to the response offer. This mode shall remain until one of the following occurs:

- The period stated by the request ends.
- The interacting actor requests the period to end.
- The consumer overrides the response operation.
- The failsafe protections occur.

The override shall be one of following:

- Modification of a planned flexibility offering or current flexibility option.
- Rejection of a requested operation.
- Cancellation of all routine and/or response mode operations for a specific interval.
- Cancellation of an ongoing routine or response mode operation.

Consolidating all the input, we concluded that the basic information that is exchanged between the energy smart appliances and the other actors can be summarised in four main signals:

1. Control signals from the Actor B (aggregator, energy manager, CEM, EMS, etc.) to the appliance. E.g., stop now, stop within xx [time period], do not start, reduce load to xx percent, stop if [condition], use own storage, etc.
2. Information signals from the Actor B to the appliance e.g., price information.
3. Control/status related signals from the appliance to the Actor B e.g., consumption information, state of the product, time to finish a cycle, expected response to DR requests or price signals (initially binary information – can/cannot respond and afterwards information on available flexibility) de-registration, DSR events and cyber-security breaches across.
4. Information signals from the appliance e.g. data related to information required to reduce energy consumption or increase appliance energy efficiency, and intended to other purpose, e.g. safety / comfort / maintenance functionalities.

In the following, we summarize the information exchanged between the energy smart appliances and the four different actors. To extract this information, we have been based on the 36 Use Cases analysed in the Annex.

Check Annex 3 to see the principle information exchange between the 4 actors (or Smart Appliances' ecosystem), regarded in sections 4.2.1, 4.2.2, 4.2.3, and 4.2.4, and the Smart Appliances.

**Table 4.** Information exchanged between energy smart appliances and the device within the house for control purposes.

| <b>Smart Appliance &lt;-&gt; Device within home for control purposes (i.e. Home Energy Gateway, EMS, etc.)</b>  |  |
|---|--|
| <b>Device within home for control purposes (i.e. Home Energy Gateway, EMS, etc.) -&gt; Smart Appliance</b>  | <b>Smart Appliance -&gt; Device within home for control purposes (i.e. Home Energy Gateway, EMS, etc.)</b>             |
| Control management data: Switch on / Switch off commands; Time slot for being active/ non active; Time window duration; schedule of activation; override commands / stop activation; store energy command; energy reduction command | Data on energy consumed; data on energy produced   |
| Control of flexibility: interrogation of the appliance if it has flexibility to offer; request flexibility  | Availability status/ update of status  |
| Information of overall consumption within the house   | Feedback on control commands: the appliance is switched on/ off, etc. (See the commands of control – previous column). |
| Warning messages: overall house consumption exceeds limits  | Request of price information/ tariffs  |
| Price information/ tariffs  |  |

Source: JRC analysis, 2022.

**Table 5.** Information exchanged between energy smart appliances and the energy service provider.

| <b>Smart Appliance &lt;-&gt; Energy Service Provider</b>  |  |
|---|--|
| <b>Energy Service Provider -&gt; Smart Appliance</b>  | <b>Smart Appliance -&gt; Energy Service Provider</b>   |
| Control management data: Switch on / Switch off commands; Time slot for being active/ non active; Time window duration; schedule of activation; override commands / stop activation; store energy command; energy reduction command | Data on energy consumed; data on energy produced   |
| Control of flexibility: interrogation of the appliance if it has flexibility to offer; request flexibility  | Availability status/ update of status  |
| Inform of emergency event, i.e. grid parameters are critical  | Feedback on control commands: the appliance is switched on/ off, etc. (See the commands of control – previous column). |
| Price information/ tariffs  | Request of price information/ tariffs  |

Source: JRC analysis, 2022.

**Table 6.** Information exchanged between energy smart appliances and the customer.

| <b>Smart Appliance &lt;-&gt; Customer</b>   |   |
|---|---|
| <b>Customer -&gt; Smart Appliance</b>   | <b>Smart Appliance -&gt; Customer</b>   |
| Comfort boundaries: time slots / duration of window for the appliances to be turned on/ off; temperature limits | Request of price information/ tariffs   |
| User presence   | Consumption/ generation data  |
| Control actions: switch on and off the appliance  | Information about flexibility to offer; information about control occurred by external actor/ device within the house |
| Activation of a non-smart appliance   | Show emergency messages: appliance will turn off; overload takes place (consumption exceeds limits)                   |

Source: JRC analysis, 2022.

**Table 7.** Information exchanged between energy smart appliances and the control point outside the house premises owned / controlled by the service provider.

| <b>Smart Appliance &lt;-&gt; control point outside the house, owned / controlled by service provider</b>  |  |
|---|--|
| <b>Control point outside the house, owned / controlled by service provider -&gt; Smart Appliance</b>  | <b>Smart Appliance -&gt; control point outside the house, owned / controlled by service provider</b>                   |
| Control management data: Switch on / Switch off commands; Time slot for being active/ non active; Time window duration; schedule of activation; override commands / stop activation; store energy command; energy reduction command | Data on energy consumed; data on energy produced   |
| Control of flexibility: interrogation of the appliance if it has flexibility to offer; request flexibility  | Availability status/ update of status  |
| Inform of emergency event, i.e. grid parameters are critical  | Feedback on control commands: the appliance is switched on/ off, etc. (See the commands of control – previous column). |
| Price information/ tariffs  | Comfort boundaries: time slots / duration of window for the appliances to be turned on/ off; temperature limits        |
|   | Request of price information/ tariffs  |

Source: JRC analysis, 2022.

As it can be seen from the Tables above, and as it can be anticipated, the smart appliance should be able to receive control commands with respect to the schedule of activation, the time slots during which it will be activated and the duration of this time slot. Depending on the type of the appliance, the control commands can differ, in the sense that for example for storage devices, there will be commands related to storage activation; for devices like washing machines, dishwashers there will be commands regarding the time window in which they should be activated. On the other hand, the smart appliance needs to communicate information like its availability status, feedback on the control commands results, like if the appliance was indeed switched on or off, etc. Another important piece of information is the comfort boundaries communicated mainly by the customer, entailing the time windows in which the appliance needs to operate and also temperature limits for appliances like air conditioners, heat pumps, etc. The energy service provider also plays an important role, especially when this actor gets to communicate directly with the appliance. An important message is the critical

conditions of the grid, for instance when a parameter exceeds its permitted values, and then this needs to be communicated.

What should also be noted here, which is not included in Table 4, Table 5, Table 6, and Table 7, is that energy smart appliances on some occasions need to auto-regulate themselves. This is mainly true for the Stand Alone DR Use Cases, where the smart appliances perform calculations in order to measure some grid parameters and adjust their consumption. Therefore, based on the pool of Use Cases we have, the energy smart appliances can perform the following tasks:

- Adjust own consumption.
- Measure grid parameters.

### **5.3 General Principles on Privacy, Safety and Cyber-security for Exchange of Energy Smart Appliances**

Given all of the above, it can be concluded that there is a lot of information that the energy smart appliances can communicate and receive from the rest of the actors in the system. The energy smart appliance is becoming a device that is able to externalise in-home information to actors outside the home. Furthermore, energy smart appliances are receiving information and perform operations based on signals from outside actors which can be open to malicious use and in some cases even prompt to attacks. Thus it is of great importance to underline that specific rules of privacy, safety and security shall be followed.

#### **5.3.1 Privacy**

Initially, the importance of the General Data Protection Regulation (GDPR) <sup>(19)</sup> and, more precisely, the consent of the consumer regarding the transfer of data to other actors, especially externals shall be stated. It is vital to have certain rules for the data to be communicated and that energy smart appliances obey to specific rules / protocols regarding the privacy of data. The connection with external actors shall be made only upon instigation from the consumer. Consumers shall have appropriate rights over the data arising from their appliances that is exchanged with third parties, with clear consent procedures that enable them to make informed decisions regarding data sharing. Data shall be securely stored when on the device or with any controlling party, and shall be capable of being securely removed when the device is recycled, reused or disposed of. Data shall be securely transmitted between devices or any controlling parties. Authentication operations shall be also performed upon connection. In addition, the end user should have the right to have his/ her data deleted upon request.

#### **5.3.2 Safety**

The energy smart appliance shall not operate in a manner that can lead to an unsafe, harmful or otherwise hazardous situation. The appliance shall take into account its operating capabilities, consumer preferences and external information (when available) as necessary. It shall be configured that safety aspects shall take priority over any other operation. Thus, it shall be able to perform an operating prioritisation, recognise an imminent condition and be able to transit into failsafe mode.

#### **5.3.3 Cyber-security**

The energy smart appliance shall conform to specific cyber security rules and shall be configured that only trusted and authorized entities are able to connect to its interfaces. On the other hand, the smart appliance shall be configured such that any logical interfaces not connected to an authorized and trust identity (e.g. unused IP ports) are closed. Firmware shall be protected, and firmware updates shall be made secure. Any passwords, identifiers and other security related data stored on the appliance (with the exception of certificates and shared keys generated during the authentication process) shall be unique.

---

<sup>(19)</sup> General Data Protection Regulation (EU) 2016/679 <https://eur-lex.europa.eu/legal-content/EN/TXT/PDF/?uri=CELEX:32016R0679>

## 6 Conclusions

In this report we present the results from three major tasks of the project. Initially we analysed all relevant sources on the interoperability of energy smart appliances such as the Ecodesing Preparatory work, deliverables from the InterConnect project, outputs from the Smart Grid Task Force, standardisation efforts in other countries or regions (i.e. UK, California, etc.), among other relevant studies. The majority of the documents reviewed, employ the practice of developing Use Cases. By consolidating this input, the current report is able to present the main Use Cases considering the interaction of energy smart appliances with their ecosystem. The main actors with which energy smart appliances are interacting and their information exchange has been consolidated.

With this, the report defines the principles of data sharing by energy smart appliances and sets the basis for our next task which is the development of interoperability requirements. This report consists the basis of further actions to be made, such as:

1. have the main guidelines for the data exchange among smart appliances;
2. create an online survey for stakeholders in order to collect data with respect to data exchange among smart appliances, i.e. which data exchange does take place, which gaps exist, etc;
3. to be as the guideline document for a workshop among stakeholders with respect to interoperability issues for smart appliances;
4. to elaborate on feedback from stakeholders and create the Code of Conduct.

As it can be concluded, this report is the first step toward the final Code of Conduct regarding interoperability among smart appliances, thus it is an important milestone to have been accomplished.



## References

**Delnooz, A., Mol, C., Gerard, H., Virag, A., Ectors, D., Bogaert, S., Huang, B. (collaboration), Viegand, J. (collaboration), Perret-Gentil, M. (collaboration), Rivière, P. (collaboration). 2018.** *Ecodesign Preparatory study on Smart Appliances (Lot 33), Tasks 1-6, Framework contract ENER.C3.2012-418-lot 1 2014/TEM/R/*. Boeretang 200 – 2400 MOL – BELGIE : VITO NV, 2018.

**Ectors, D., Gerard, H., Rivero, E., Vanthournout, K., Verbeeck, J., Virag, A., Huang, B., Viegand, J., Stamminger, R., Geppert, J., Perret-Gentil, M., Rivière, P., Götz, T. 2018.** *Ecodesign Preparatory study on Smart Appliances (Lot 33), Tasks 7, Framework contract ENER.C3.2012-418-lot 1 2014/TEM/R/*. Boeretang 200 – 2400 MOL – BELGIE : VITO NV, 2018.

**INESCTEC,VLF,TNO,TRIALOG – Interconnect. 2020.** *D5.2 Data Flow Management*. s.l. : VLF, 2020. WP5 – Digital Platforms and Marketplace.

**The British Standards Institution – PAS1878:2021. 2021.** PAS 1878:2021. *Energy smart appliances – System functionality and architecture – Specification*. s.l. : Published by BSI Standards Limited 2021., 2021. ISBN 978 0 539 05131 5. ICS 03.100.70; 27.015; 91.140.50.

**Valdez, A., Thakkar, M., Nubbe, V., Reich, J., Goetzler, W. 2020.** *Energy Applications within IoT and Digitalisation Strategies*. s.l. : Guidehouse Inc., 2020. Prepared for: The Electronic Devices & Networks Annex of the IEA 4E Technology Collaboration Programme.

**WP1 Pilot Partners – InterConnect. 2021.** *D1.2 Mapping between use cases and large-scale pilots*. s.l. : EEBUS INITIATIVE E.V., 2021. WP1 – Use Cases, Business Models and Services.

## List of Abbreviations and Definitions

|       |  |
|-------|--|
| 4E    | Efficient End-Use Equipment                          |
| AC    | Air condition  |
| AMI   | Advance Metering Infrastructure                      |
| API   | Application Programming Interface                    |
| APP   | Application  |
| BRP   | Business Response Provider                           |
| BACS  | Building Acquisition Control System                  |
| CEM   | Customer Energy Management                           |
| CFL   | Compact fluorescent light                            |
| CIM   | Common Information Model                             |
| CoC   | Code of Conduct                                      |
| DSO   | Distribution System Operator                         |
| DSR   | Demand Side Response                                 |
| DSRSP | Demand Side Response Service Provider                |
| EC    | European Commission                                  |
| EDNA  | Electronic Devices and Network Annex                 |
| EMS   | Energy Management System                             |
| ESA   | Energy Smart Appliance                               |
| ETSI  | European Telecommunications Standards Institute      |
| EV    | Electric Vehicle                                     |
| FSP   | Flexibility Service Provider                         |
| FO    | Flexibility Owner                                    |
| GLS   | General lighting service                             |
| GUI   | Graphical User Interface                             |
| HID   | High intensity discharge lamp                        |
| HLUC  | High Level Use Case                                  |
| HVAC  | Heating, Ventilation and Air-Conditioning            |
| IoT   | Internet of Things                                   |
| IP    | Internet Protocol                                    |
| JRC   | Joint Research Centre                                |
| LED   | Light emitting diode                                 |
| LFL   | Linear fluorescent lamp                              |
| MEErP | Methodology for ecodesign of energy-related products |
| MWh   | Mega Watt Hour                                       |
| NGO   | Non-Governmental Organisation                        |
| PAS   | Public Available Specification                       |
| PEM   | Pilot Energy Manager                                 |
| PLC   | Power Line Communication                             |

|        |  |
|--------|--|
| PUC    | Primary Use Case                           |
| PV     | Photovoltaic                               |
| RES    | Renewable Energy Sources                   |
| SAREF  | Smart Applications Reference               |
| SGDOIT | Smart Grid Design of Interoperability Test |
| SHT    | Smart Home Technologies                    |
| UC     | Use Case                                   |
| VPP    | Virtual Power Plant                        |

**List of figures**

**Figure 1.** Data transfers between the appliances and the power system.....10

**Figure 2.** Flexibility functional architecture as proposed by the CEN-CENELEC-ETSI Smart Grid Coordination Group.....11

**Figure 3.** Example of the complexity of the in home interoperability: variety of communication technologies and protocols.....11

**Figure 4.** Illustration setups emerging from the combination of CEM and IoT technology.....12

**Figure 5.** French Pilot.....14

**Figure 6.** The German Pilot (Norderstedt).....15

**Figure 7.** The Italian Pilot.....15

Figure 8. The Dutch Pilot.....16

**Figure 9.** Sequence diagram of the Dutch Pilot.....17

**Figure 10.** Interconnect Adapter: High level overview of the concept.....18

**Figure 11.** Representation of system level CEM-ESA energy flexibility architecture with separate CEM/ESAG.20

**Figure 12.** Summary of smart definitions.....21

**Figure 13.** Message sequence chart for generic Use Case, a) Communication of energy smart appliances through the home energy gateway, b) Communication of energy smart appliances directly to the energy service provider through the cloud.....25

**Figure 14.** Message Sequence Chart for the generic Use Case of explicit demand response.....26

**Figure 15.** Message Sequence Chart for the generic use case of implicit demand response.....26

**Figure 16.** Message Sequence Chart for the generic use case of local optimal energy consumption.....27

**Figure 17.** Message Sequence Chart for the generic Use Case of Standalone demand response.....27

**Figure 18.** Message Sequence Chart for UC 1 – Belgium (Flemish Region).....43

**Figure 19.** Message Sequence Chart for UC 2 – Australia (South East Queensland) .....44

**Figure 20.** Message Sequence Chart for UC 3 – Germany.....44

**Figure 21.** Message Sequence Chart for UC 4 – United States (Austin).....45

**Figure 22.** Message Sequence Chart for UC 5 – United States (California).....45

**Figure 23.** Message Sequence Chart for UC 1 – Belgium (Flemish region).....46

**Figure 24.** Message Sequence Chart for UC 2 – Germany (Cuxhaven Region – Lower Saxony).....46

**Figure 25.** Message Sequence Chart for UC 3 – Netherlands.....46

**Figure 26.** Message Sequence Chart for UC 1 – Germany (Cuxhaven Region – Lower Saxony).....47

**Figure 27.** Message Sequence Chart for UC 2 – United States.....47

**Figure 28.** Message Sequence Chart for UC 1 – Belgium (Flemish region).....48

**Figure 29.** Message Sequence Chart for UC 2 – United States (Pacific Northwest).....48

**Figure 30.** Message Sequence Chart for UC 1 – Load shifting of heat pump supplied houses.....49

**Figure 31.** Message Sequence Chart for UC 2 - Self-consumption of on-site produced RES energy.....49

**Figure 32.** Message Sequence Chart for UC 3 - Variable pricing support by a washing machine.....50

**Figure 33.** Message Sequence Chart for UC 4 - Appliance-based system frequency control of freezers.....50

|  |    |
|--|----|
| <b>Figure 34.</b> Message Sequence Chart for UC 5 - Distribution grid congestion management by buffered water heaters.....   | 50 |
| <b>Figure 35.</b> Message Sequence Chart for UC 6 - Frequency restoration reserves based on commercial refrigeration.....  | 51 |
| <b>Figure 36.</b> Message Sequence Chart for UC 7 - Peak shaving combined with energy efficiency by appliances controlled by a building automation and control system..... | 51 |
| <b>Figure 37.</b> Message Sequence Chart for PUC 1.....  | 52 |
| <b>Figure 38.</b> Message Sequence Chart for PUC 2.....  | 53 |
| <b>Figure 39.</b> Message Sequence Chart for PUC 3.....  | 53 |
| <b>Figure 40.</b> Message Sequence Chart for PUC 4.....  | 53 |
| <b>Figure 41.</b> Message Sequence Chart for PUC 5.....  | 54 |
| <b>Figure 42.</b> Message Sequence Chart for PUC 6.....  | 54 |
| <b>Figure 44.</b> Message Sequence Chart for PUC 8.....  | 55 |
| <b>Figure 45.</b> Message Sequence Chart for PUC 9.....  | 55 |
| <b>Figure 46.</b> Message Sequence Chart for HLUC 1.....   | 56 |
| <b>Figure 47.</b> Message Sequence Chart for HLUC 2.....   | 58 |
| <b>Figure 48.</b> Message Sequence Chart for UC 1 – Devices that can be controlled to free up time.....  | 59 |
| <b>Figure 49.</b> Message Sequence Chart for UC 2 – Information control (control by building manager).....   | 59 |
| <b>Figure 50.</b> Message Sequence Chart for UC 2 – Information control (control by aggregator).....   | 60 |
| <b>Figure 51.</b> Message Sequence Chart for UC 1 – Visualization of consumption data.....   | 60 |
| <b>Figure 52.</b> Message Sequence Chart for UC 2 – Setting of a smart appliance according to price tariffs.....   | 61 |
| <b>Figure 53.</b> Message Sequence Chart for UC 3 – Control of smart appliance in case of overload.....  | 61 |
| <b>Figure 54.</b> Message Sequence Chart for UC 4 – Interaction of smart meter.....  | 62 |
| <b>Figure 55.</b> Overview of the main classes of the SAREF ontology.....  | 63 |
| <b>Figure 56.</b> Message Sequence Chart for the generic Use Case of explicit demand response.....   | 64 |
| <b>Figure 57.</b> Message Sequence Chart for the generic use case of implicit demand response.....   | 65 |
| <b>Figure 58.</b> Message Sequence Chart for the generic use case of local optimal energy consumption.....   | 66 |
| <b>Figure 59.</b> Message Sequence Chart for the generic Use Case of Standalone demand response.....   | 67 |

**List of tables**

**Table 1.** Energy smart appliances categorization..... 6

**Table 2.** Actors interacting with energy smart appliances.....28

**Table 3.** Interactions of energy smart appliances with other actors based on the analysed Use Cases.....29

**Table 4.** Information exchanged between energy smart appliances and the device within the house for control purposes.....33

**Table 5.** Information exchanged between energy smart appliances and the energy service provider.....33

**Table 6.** Information exchanged between energy smart appliances and the customer.....34

**Table 7.** Information exchanged between energy smart appliances and the control point outside the house premises owned / controlled by the service provider.....34

**Table 8.** High Level Use Cases and their connection to the Primary Use Cases.....52

**Table 9.** Consumer profile set for a more specific General UC defined in section 4.2.1.....64

**Table 10.** Consumer profile set for a more specific General UC defined in section 4.2.2.....65

**Table 11.** Mapping each general UC, described in all four sections of this annex, with the SAREF ontology.....68

**Table 12.** Grouping of messages exchanged between the four actors and energy smart appliance referred in section 5.2.....70

## Annexes

### Annex 1: Categorization of Use Cases

#### **Representation of Use Cases on Smart Appliances based on the Ecodesign Preparatory Study on Smart Appliances, Task 7**

As it has been discussed in Chapter 4, the Use Cases on which this analysis has been based are analysed and presented here.

#### **Explicit Demand Response Use Cases**

At this point, we give a short description and further present the Message Sequence Charts of the Use Cases analysed from page 47 to 50 of the *Task 7* (Ectors, 2018). These Message Sequence Charts give a graphical representation of the actors involved and the information exchanged.

##### — UC 1: Belgium (Flemish Region).

This Use Case tests the potential of residential demand response. The customer receives a reward for offering flexibility from his/ her energy smart appliances. The customer sets comfort data for the usage of energy smart appliances. This comfort data is transferred to the Linear Pilot Backend, where calculations are made and actions are decided based on the total hours of delay configured by the user. In general, the Linear Pilot Backend is where all operations for the pilot are made.

**Figure 18.** Message Sequence Chart for UC 1 – Belgium (Flemish Region).

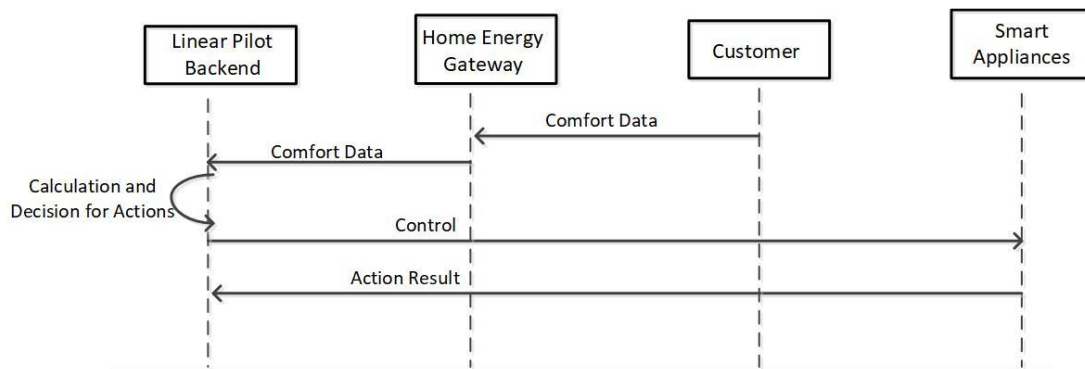

Source: JRC analysis, 2022.

##### — UC 2: Australia (South East Queensland).

In this Use Case, the Energy Company offers a program for air conditioners in order to reduce their peak consumption. The consumers only interact with their smart appliance (air condition) to set comfort data, which is sent then to the signal receiver. This signal receiver interacts with the smart appliance and the energy company. The energy company sends a signal when peak demand is reached to the signal receiver, so as to decrease the demand of a specific air condition. The customers receive rewards according to the energy that has been curtailed in total from their smart appliance.

**Figure 19.** Message Sequence Chart for UC 2 – Australia (South East Queensland).

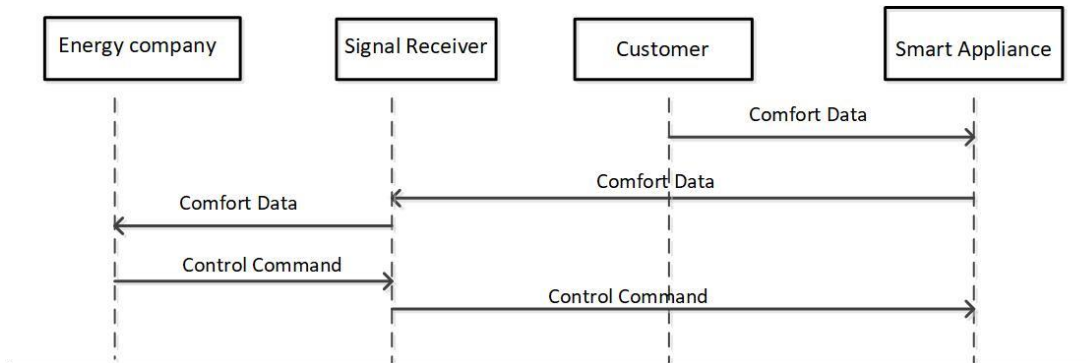

Source: JRC analysis, 2022.

— UC 3: Germany.

This Use Case aims to obtain flexibility from appliances with thermal flexibility potential. The energy company has created an intelligent load manager (VPP) in order to control generation and consumption through a common control room. This VPP gathers generation and consumption data from wind farms/ PVs and refrigerated warehouses and together with market data calculates the schedule for consumption which is sent to the energy company’s operators. From that point, the operators are the ones to give authorization to buy electricity and to schedule the consumption of the appliances (i.e. refrigerated warehouse), *Task 7*.

**Figure 20.** Message Sequence Chart for UC 3 – Germany.

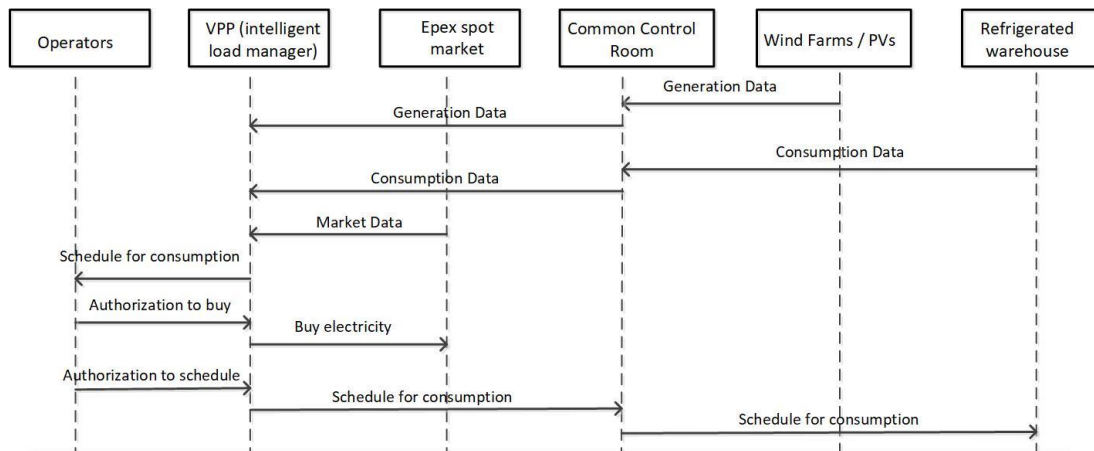

Source: JRC analysis, 2022.

— UC 4: United States (Austin).

This Use Case deals with thermostats. The energy company is allowed to control thermostats, which subsequently turn on and off the equivalent smart appliance, according to rush hour information. The thermostats obtain information about these rush hours, as well as information about historical data (i.e. how quickly or not the house can get cooled down or heated up); it also collects information from users (i.e. comfort boundaries). It makes adjustments about the temperature settings and sends the control command to the smart appliance, *Task 7*.



**Figure 21.** Message Sequence Chart for UC 4 – United States (Austin).

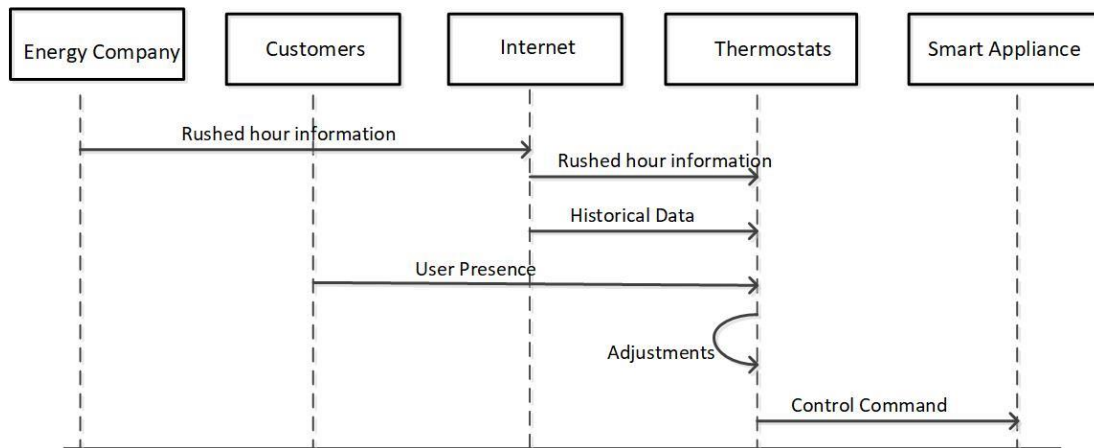

Source: JRC analysis, 2022.

— UC 5: United States (California).

This Use Case deals with Electric Vehicles and their charging. The electric company gets information about when energy is needed from the management system of utilities. There is communication of the electric company and the consumers through the JuiceNet product, where consumers send their comfort data. This product also receives schedules from the electric company as to when to charge the electric vehicle, so as to increase the usage of energy produced by renewable sources. There is the option to overwrite commands for vehicle charging by the user, *Task 7*.

**Figure 22.** Message Sequence Chart for UC 5 – United States (California).

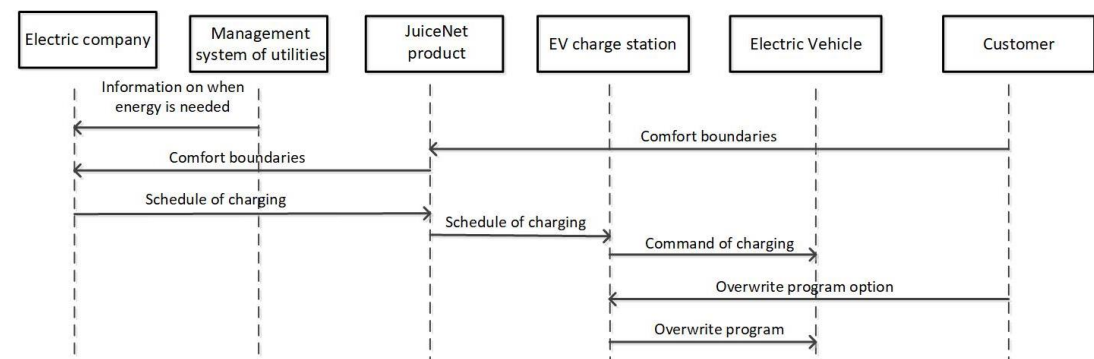

Source: JRC analysis, 2022.

**Implicit Demand Response Use Cases**

In the following, we firstly give a short description of each Use Case, as this is found in pages 51 and 52 of this *Task 7* (Ectors, 2018), and we give its representation in the equivalent Message Sequence Charts. These Message Sequence Charts give a graphical representation of the actors involved and the information exchanged.

— UC 1: Belgium (Flemish region).

This Use Case deals with appliances that are not smart. The customers receive price signals (incentives) through a linear portal and they subsequently react to them by manually switching on and off their appliances. Remuneration is offered to clients by comparing their reference electricity consumption and the energy shifts achieved, (*Task 7*).

**Figure 23.** Message Sequence Chart for UC 1 – Belgium (Flemish region).

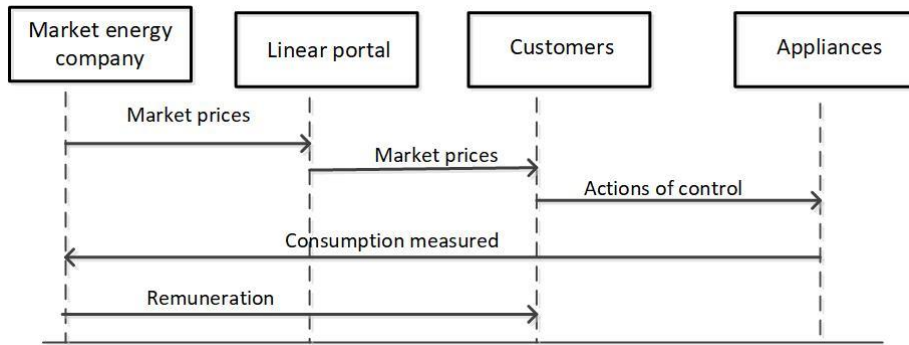

Source: JRC analysis, 2022.

— UC 2: Germany (Cuxhaven Region – Lower Saxony).

This Use Case describes the response of consumers to different tariffs offered by the electricity provider (we refer to the electricity provider as Actor A). So, the program included different tariffs offered for electricity consumption. The consumers needed to respond manually to the observed prices and adjust their consumption accordingly. Thus, energy smart appliances are not necessarily involved here. In the end of the project, it has been calculated the electricity savings with respect to reference consumption.

**Figure 24.** Message Sequence Chart for UC 2 – Germany (Cuxhaven Region – Lower Saxony).

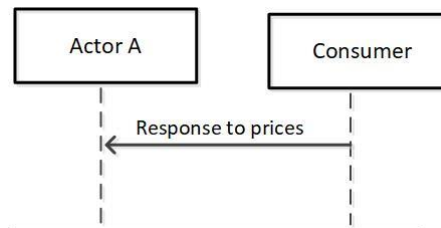

Source: JRC analysis, 2022.

— UC 3: Netherlands.

This Use Case deals with electric vehicles charging. The company that offers electricity (Jedlix) has created an application for consumers in order to schedule electric vehicles charging. The consumer sets comfort boundaries to this application and it also takes into account information with respect to energy prices. The application calculates the ideal charging pattern and sends the command for charging. In case the user is on the road, the app directs him/ her to the nearest charging point.

**Figure 25.** Message Sequence Chart for UC 3 – Netherlands.

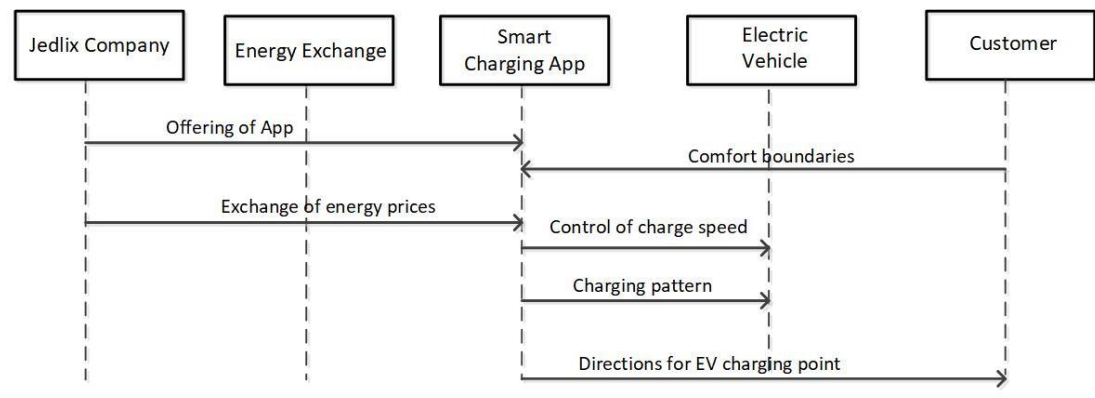

Source: JRC analysis, 2022.

**Representation of Use Cases on Smart Appliances based on the Ecodesign Preparatory Study on Smart Appliances, Task 7 – Local Optimal Energy Consumption Use Cases**

At this point, we present the Message Sequence Charts of the Use Cases under this category, as these are found in pages 53 and 54 of this Task 7 (Ectors, 2018).

— UC 1: Germany (Cuxhaven Region – Lower Saxony).

This Use Case deals with a storage system. This system stores energy from PVs when the latter is not consumed. It is capable of providing the energy needed for a household locally at the extent of 70%, while the rest of the energy is given by the grid and it is produced also by renewable energy sources. The user can give his/ her feedback with respect to how the energy should be used and stored. In case of excess energy produced, this is returned to the grid after one day of storage in the system.

**Figure 26.** Message Sequence Chart for UC 1 – Germany (Cuxhaven Region – Lower Saxony).

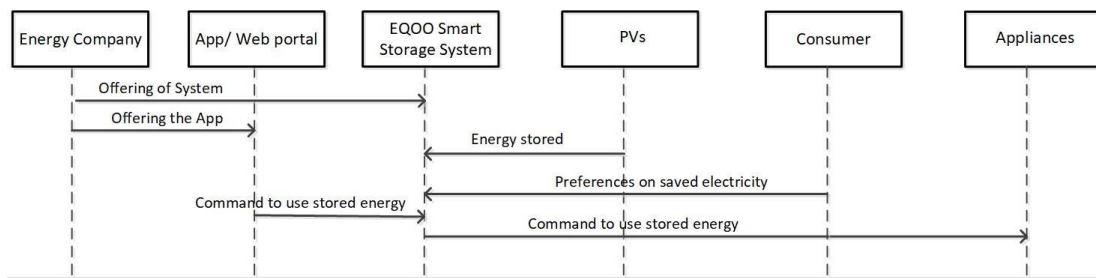

Source: JRC analysis, 2022.

— UC 2: United States.

This Use Case also deals with production and consumption of electricity locally. For this purpose, two products are available to the consumer, the Solar Roof and the Powerwall home battery. The user can control these products through an application, thus he/ she can control the energy produced locally and stored for future use.

**Figure 27.** Message Sequence Chart for UC 2 – United States.

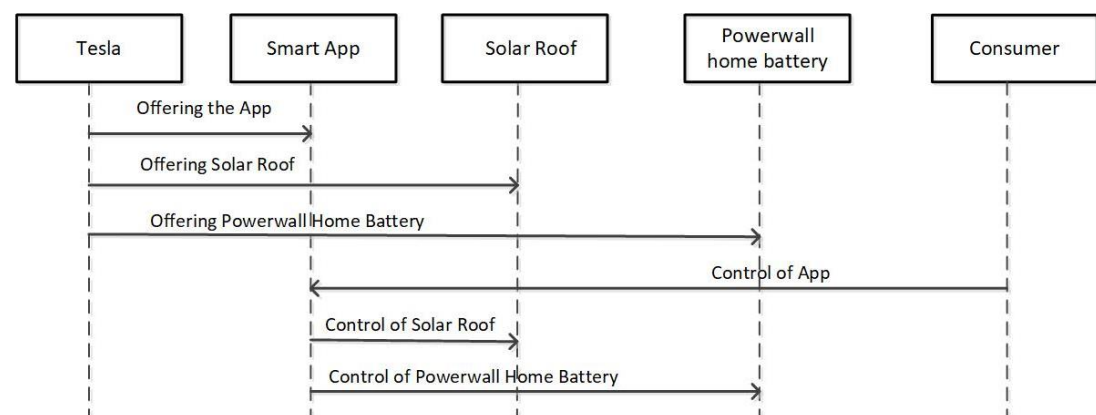

Source: JRC analysis, 2022.

**Representation of Use Cases on Smart Appliances based on the Ecodesign Preparatory Study on Smart Appliances, Task 7 – Standalone Demand Response Use Cases**

We now present the examples of Use Cases that belong to this category, as these are found in this Task. We give the representation of these Use Cases, gathered from page 54 to 56 in Task 7 (Ectors, 2018), regarding their message sequence charts and a short description for them.

— UC 1: Belgium (Flemish Region).

This Use Case implies that multiple energy smart appliances are available within the household. A control mechanism measures the voltage and, given the flexibility from the appliances, tries to balance under- or over- voltage episodes by controlling of the appliances consumption. The goal is to bring voltage to acceptable levels. Remuneration is provided to consumers according to the flexibility provided. The consumers interact with their energy smart appliances by providing comfort boundaries.

**Figure 28.** Message Sequence Chart for UC 1 – Belgium (Flemish region).

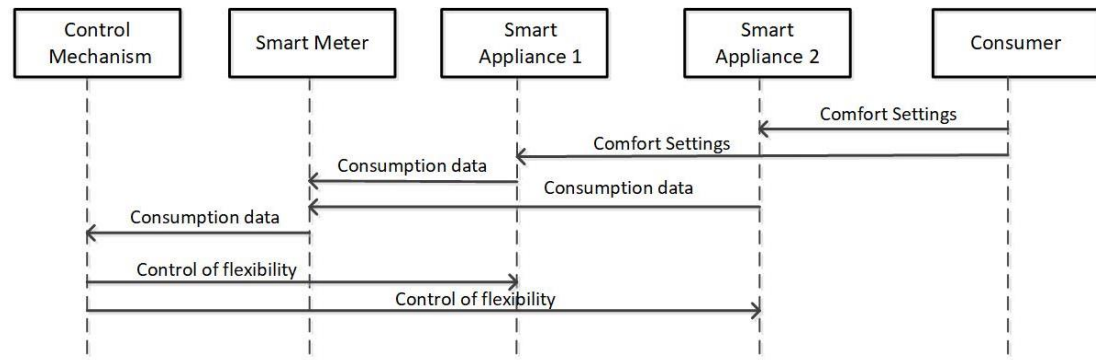

Source: JRC analysis, 2022.

— UC 2: United States (Pacific Northwest).

This Use Case involves a Grid Friendly Appliance Controller that measures under-frequency events. It then tries to adjust consumption of energy smart appliances so as to achieve normal frequency. The system works autonomously.

**Figure 29.** Message Sequence Chart for UC 2 – United States (Pacific Northwest).

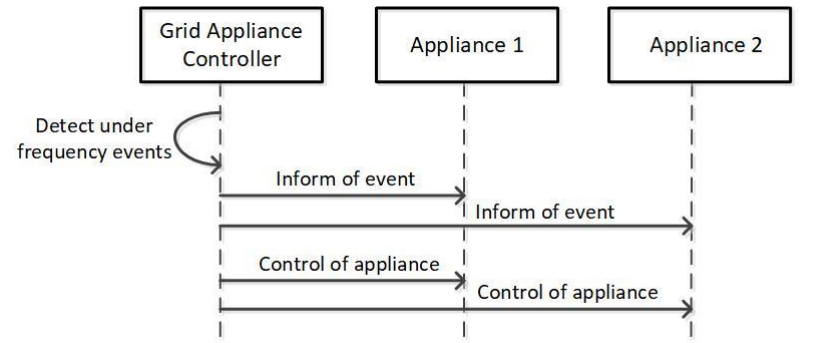

Source: JRC analysis, 2022.

**Representation of Use Cases on Smart Appliances based on the Ecodesign Preparatory Study on Smart Appliances, Tasks 1–6**

In this Section, we analyse the Use Cases on Smart Appliances as these are presented in (Delnooz, 2018). We firstly give a short description of each Use Case presented and afterwards we show their Message Sequence Charts. As mentioned beforehand, the added value in this report is the representation of the Message Sequence Charts, which illustrate the interactions among actors and from which other valuable conclusions can be driven, i.e. prerequisites for the interactions, thus also for the Use Case to take place.

— UC 1: Load shifting of heat pump supplied houses.

This Use Case deals with an aggregator communicating with multiple houses, in order to control their heat pumps. The scope is to reduce consumption by decreasing the usage of heat pumps in many houses together. For this purpose, messages are sent to Home Energy Gateways so as to switch on the equivalent heat pumps. A prerequisite is that sufficient heat is stored in the building components so as to minimize the discomfort to users.

**Figure 30.** Message Sequence Chart for UC 1 – Load shifting of heat pump supplied houses.

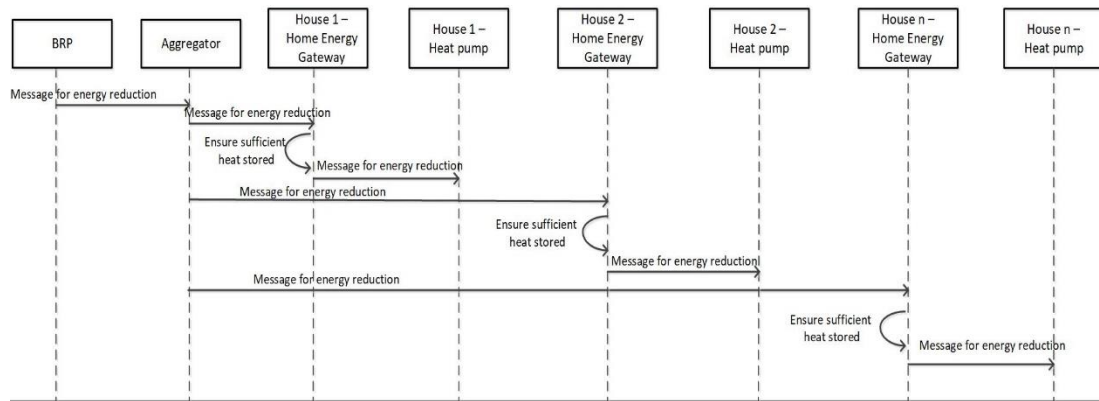

Source: JRC analysis, 2022.

— UC 2: Self-consumption of on-site produced RES energy.

In this Use Case, everything takes place at consumer premises. The scope is to maximize self-consumption, energy produced locally by renewable energy sources. Therefore, a Home Energy Controller exists that calculates when production of electricity exceeds consumption. In such case, it orders to charge the battery. Otherwise, it orders its discharging. This Use Case has as a prerequisite that the prosumer will be in possession of renewable energy sources and a battery, (Task 1-6).

**Figure 31.** Message Sequence Chart for UC 2 - Self-consumption of on-site produced RES energy.

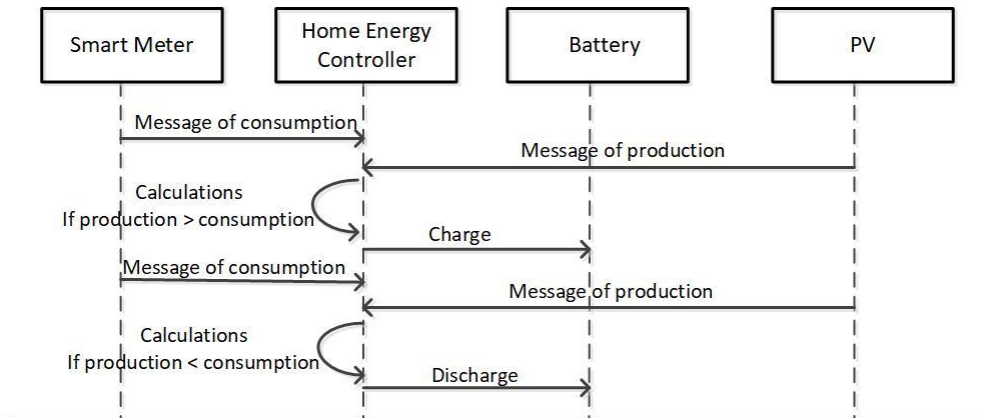

Source: JRC analysis, 2022.

— UC 3: Variable pricing support by a washing machine.

This Use Case deals with smart washing machines. Such washing machines download the electricity prices from the market and calculate when the best moment to switch on is. A user interface is also used so as the user inserts comfort boundaries for the washing machine to execute its program. This Use Case implies that variable tariffs are available for the end user.

**Figure 32.** Message Sequence Chart for UC 3 - Variable pricing support by a washing machine.

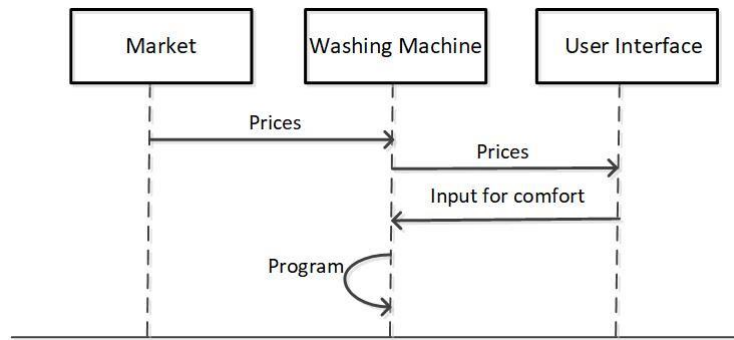

Source: JRC analysis, 2022.

- UC 4: Appliance-based system frequency control of freezers.

This Use Case deals with energy smart appliances that are able to measure certain parameters of the grid, i.e. voltage or frequency and act accordingly in order to guarantee grid stability. The appliances mentioned in particular are the freezers. Whenever one of the grid parameters deviates from its normal value, the appliance chooses to switch on/ off accordingly to ensure grid stability.

**Figure 33.** Message Sequence Chart for UC 4 - Appliance-based system frequency control of freezers.

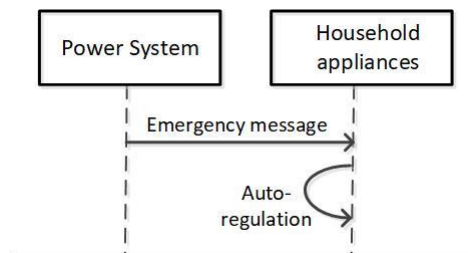

Source: JRC analysis, 2022.

- UC 5: Distribution grid congestion management by buffered water heaters.

This Use Case deals with water heaters in order to avoid an overvoltage event on the grid. So, when electricity production from solar panels is at maximum, the water heaters are turned on. The heat is stored in the buffer and remains there until it is asked by the user.

**Figure 34.** Message Sequence Chart for UC 5 - Distribution grid congestion management by buffered water heaters.

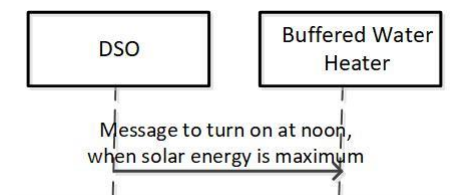

Source: JRC analysis, 2022.

- UC 6: Frequency restoration reserves based on commercial refrigeration.

This Use Case deals with commercial refrigerators and freezers. If electricity production is below a limit, the TSO sends a message to the Energy Management System of the owner of these fridges/ freezers in order to switch off. Otherwise, if electricity production is over a certain limit, the message indicates that the freezers / fridges are turned on. A prerequisite is that the temperature of fridges / freezers does not go beyond certain limits.

**Figure 35.** Message Sequence Chart for UC 6 - Frequency restoration reserves based on commercial refrigeration.

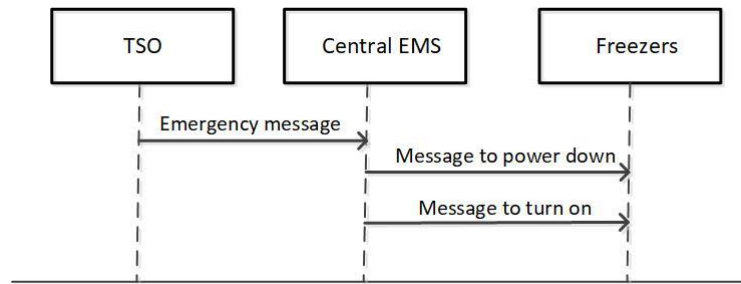

Source: JRC analysis, 2022.

- UC 7: Peak shaving combined with energy efficiency by appliances controlled by a building automation and control system.

This Use Case has to do with smart buildings. The building automation control system regulates the consumption of the building, by turning off its energy smart appliances, whenever a peak shaving message is received by the aggregator. The owner of the building gets to be remunerated for such action. Consumption shaving is done within a window frame, i.e. 3 hours, during which the appliances are controlled so as to reduce their consumption. Outside this time window, the appliances are controlled in such a way, so as to maximise energy efficiency of the building.

**Figure 36.** Message Sequence Chart for UC 7 - Peak shaving combined with energy efficiency by appliances controlled by a building automation and control system.

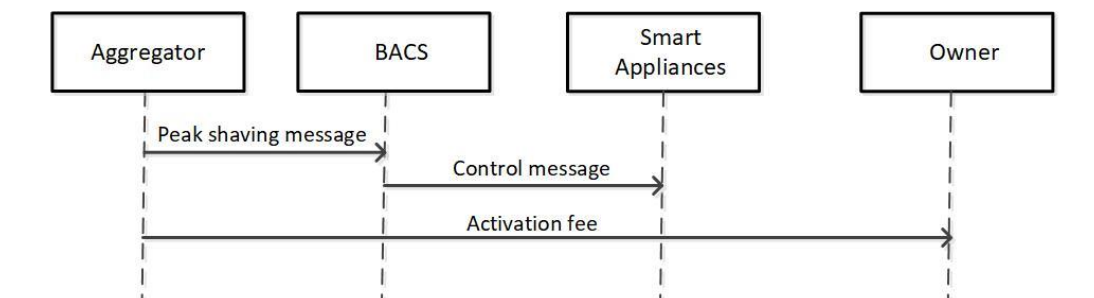

Source: JRC analysis, 2022.

**Representation of Use Cases on Smart Appliances based on Interconnect Project – Mapping between Use Cases and Large-scale Pilots**

The project Interconnect has multiple pilot sites, two of which are the French and the Dutch pilot site, which describe Use Cases including energy smart appliances. In the following, we present the Use Cases described for these pilot sites giving their message sequence charts and a short description. All of them can be found in (WP1 Pilot Partners - InterConnect, 2021).

**The French Pilot site**

For the French pilot site, there are two High Level Use Cases (HLUC) described, the business Use Cases and 9 Primary Use Cases (PUC), which make part of these two High Level Use Cases. We present the HLUCs and then we demonstrate the PUCs. The HLUCs and their connection to the PUCs are shown in Table 8. Thereafter, we first describe the PUCs and then the HLUCs. We present the message sequence charts, on which the data principles are exchanged. It should be noted that the diagrams for the PUCs are created in this report based on the information found in (WP1 Pilot Partners - InterConnect, 2021), whereas the diagrams for the HLUCs are based on the diagrams of the same source; combined with the information included in the PUCs. The scope for representing the message sequence charts for the HLUCs has been to represent in a single diagram information about the HLUC itself along with the information of the PUCs it entails. Therefore, the aforementioned diagrams for the HLUCs have been enriched to include the information characterizing the PUCs that correspond to each HLUC.

**Table 8.** High Level Use Cases and their connection to the Primary Use Cases.

| <b>Maximize the Use of Local RES</b>            | <b>Dynamic Tariff and Usage Management</b>      |
|---|---|
| 1. Production PV                                | 2. Setup of the end user preferences            |
| 2. Setup of the end user preferences            | 3. Provide a contract to the customer           |
| 3. Provide a contract to the customer           | 4. EMS processing and operations                |
| 4. EMS processing and operations                | 5. Smart Orchestrator Processing and Operations |
| 5. Smart Orchestrator Processing and Operations | 6. The end-user takes the control               |
| 6. The end-user takes the control               | 7. Provide Dynamic Tariff to the end-user       |
|   | 8. Providing Dynamic Tariff                     |
|   | 9. Providing Flexibility                        |

Source: JRC analysis, 2022.

### Primary Use Cases (PUC)

Here, we give a short description of the PUCs, as these are described in the Interconnect project. We give a short description and present their message sequence charts, showing the interactions of actors and the exchange of data.

#### — PUC 1: Production PV.

This PUC deals with the energy produced by photovoltaic panels. The energy is produced and the smart orchestrator and service provider are informed about such events. This helps subsequently the system to make the most out of this energy produced, so as it is consumed locally.

**Figure 37.** Message Sequence Chart for PUC 1.

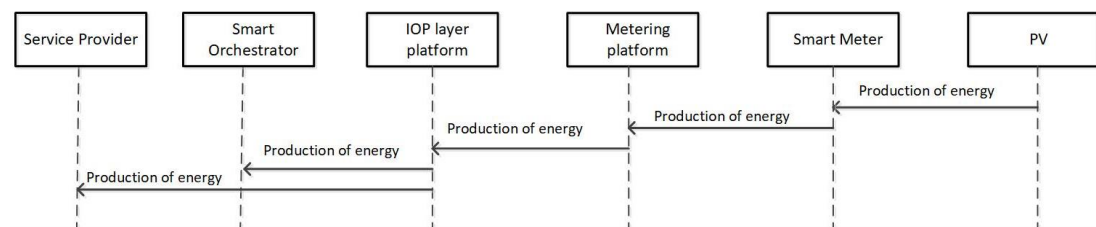

Source: JRC analysis, 2022.

#### — PUC 2: Setup of End-user preferences.

The goal of this PUC is to give the chance to the user to set his/ her preferences with respect to the automatic functionality of the energy smart appliances. The end user sets his/ her preferences via the graphical user interface (GUI), which communicates with the smart orchestrator. The smart orchestrator can enable remote control of such appliances automatically. It also communicates the comfort settings to the EMS. Acknowledgements are sent to reassure that messages have been received. The GUI is the means to inform the service provider about the preferred schedule of the end user.



**Figure 38.** Message Sequence Chart for PUC 2.

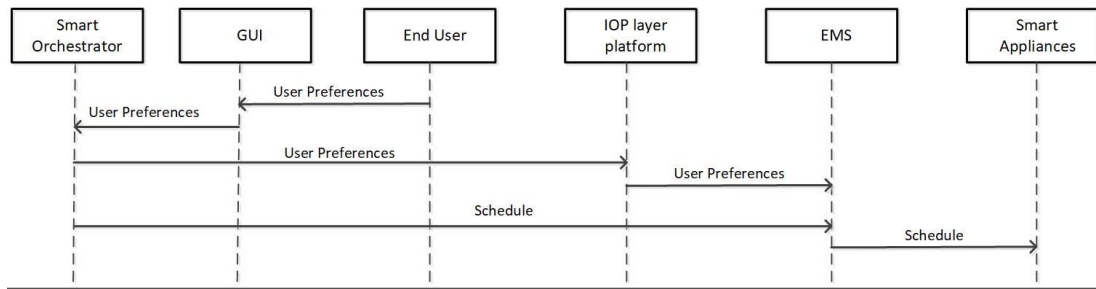

Source: JRC analysis, 2022.

— PUC 3: Provide a contract to the customer.

The aim of this PUC is to provide attractive contracts to customers, such as to maximise RES energy and make use of dynamic tariffs. The relevant actors are the customers, the service provider, the DSO and the installer.

**Figure 39.** Message Sequence Chart for PUC 3.

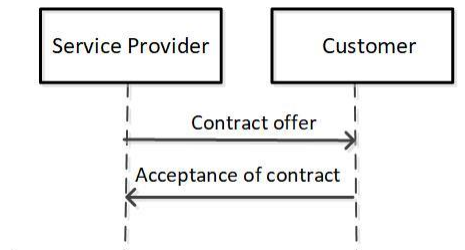

Source: JRC analysis, 2022.

— PUC 4: EMS processing and behaviour / EMS functioning.

This UC deals with the EMS controlling the functionality of the energy smart appliances according to what the smart orchestrator has indicated. The goal is to maximize local energy consumption or make optimal usage of dynamic tariffs. The EMS controls the available flexibility from the energy smart appliances and sets their functionality in accordance.

**Figure 40.** Message Sequence Chart for PUC 4.

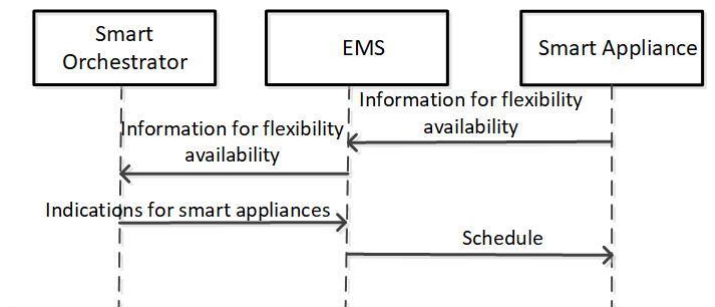

Source: JRC analysis, 2022.

— PUC 5: Smart Orchestrator Processing and Operations.

This UC, as the name implies is about setting the scheduling of energy smart appliances within the house from an external actor. To initiate the operations of the smart orchestrator, the user preferences need to be considered. The smart orchestrator takes into account also the RES availability and the dynamic tariff program. The overall scheduling of devices targets to minimize energy consumption, to maximize usage of RES energy locally and minimize costs for end user by using

dynamic tariffs, thus operating devices when tariffs are the most convenient. Before turning on a smart appliance, the EMS needs to ask authorization from the smart orchestrator.

**Figure 41.** Message Sequence Chart for PUC 5.

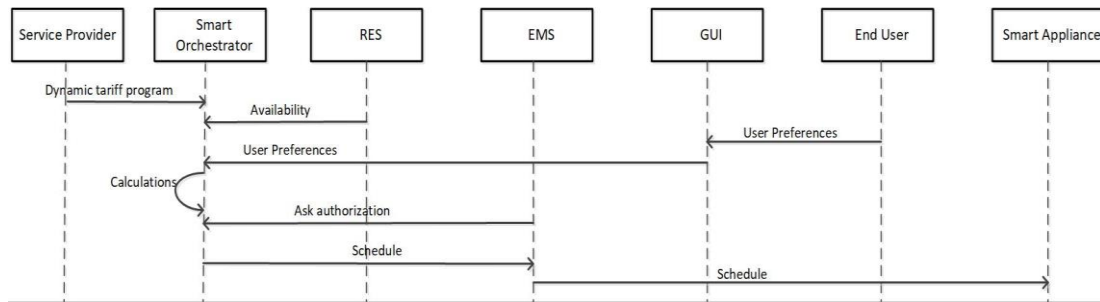

Source: JRC analysis, 2022.

— PUC 6: The end user takes the control.

The goal of this UC is to give the end user the opportunity to take over control of devices in case he/she desires to do so. Thus, independently of the automatic control of devices, the user can always override the automatic commands and alter their functionality according to his/ her needs. This ultimate control takes place through the GUI.

**Figure 42.** Message Sequence Chart for PUC 6.

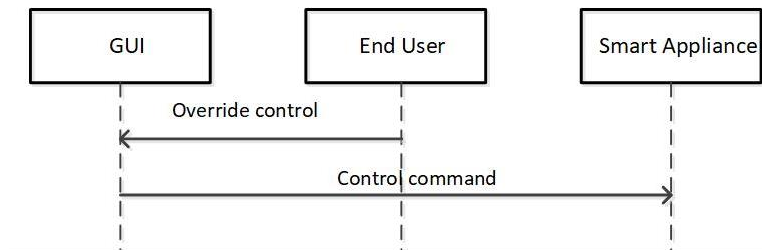

Source: JRC analysis, 2022.

— PUC 7: Provide dynamic tariff to the end user.

The scope of this UC is to offer dynamic tariffs to customers. Such tariffs are sent by the retailer to the GUI of the customer, who can decide to use the energy smart appliances according to such tariff schedules.

**Figure 43.** Message Sequence Chart for PUC 7.

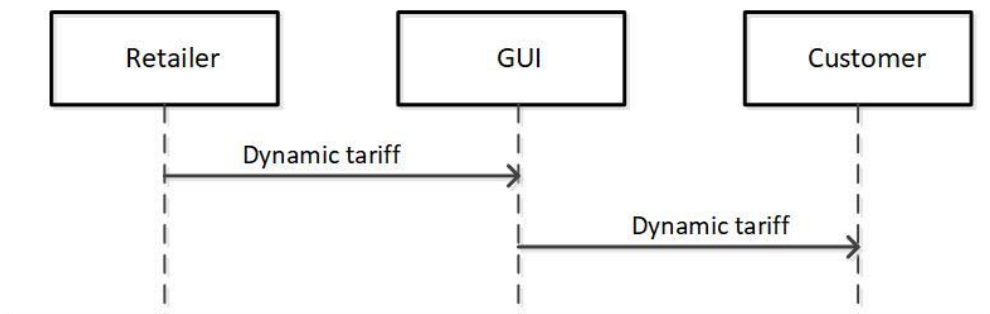

Source: JRC analysis, 2022.

— PUC 8: Provide dynamic tariff to the Smart Orchestrator.

The scope of this UC is to give the opportunity to the smart orchestrator to schedule the energy smart appliances in the best possible way. For this reason, the smart orchestrator receives dynamic tariff by the retailer along with comfort boundaries from the end user in order to enable an effective schedule of the appliances.

**Figure 44.** Message Sequence Chart for PUC 8.

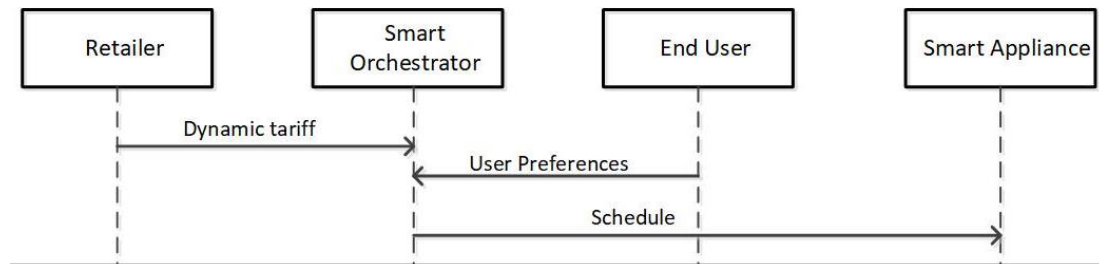

Source: JRC analysis, 2022.

— PUC 9: Provide Flexibility to the Grid.

This UC deals with flexibility offered to the TSO by the Flexibility Service Provider (FSP), which in turn receives the flexibility from its Flexibility Owners (FO). These FOs, get flexibility from the equivalent energy smart appliances, after requests made to them. The FSP and FO agree on the necessary amounts of capacities and availability planning.

**Figure 45.** Message Sequence Chart for PUC 9.

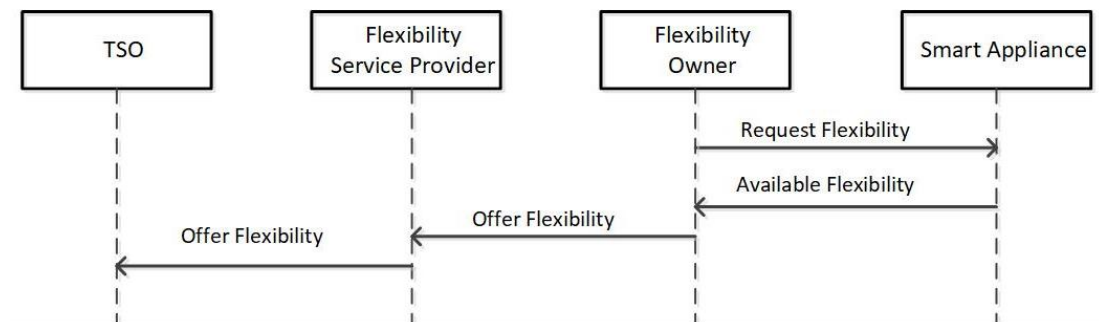

Source: JRC analysis, 2022.

High Level Use Cases (HLUC)

— HLUC 1: Maximize the Use of Local RES.

This Use Case, as the name implies, aims at maximizing the production of electricity by RES at local premises. For this purpose, the period of RES (mainly PVs) energy production needs to be known and synchronized with the consumption of appliances. The buildings to take part in this initiative are mainly municipal buildings. The usage of energy smart appliances can be regulated remotely by the user through several interfaces. The end-user sets comfort boundaries with respect to the functionality of such appliances. The service provider can also monitor and activate/ deactivate these appliances in an automatic way, taking into account user preferences.



— HLUC 2: Dynamic Tariff and Usage Management.

This Use Case aims at minimizing costs for end-user with respect to functioning the energy smart appliances when tariffs are the lowest. For this, programming is needed to schedule the appliances functionality accordingly. Such different tariffs need to be well published and known by the end users. The end-user in his/ her turn, can control the functionality of the energy smart appliances through online Apps. User preferences are also set by the end users. Again, the service providers, can control such appliances remotely, considering comfort settings set by end users, as well as constraints regarding the grid (i.e. grid congestion issues).

**Figure 47.** Message Sequence Chart for HLUC 2.

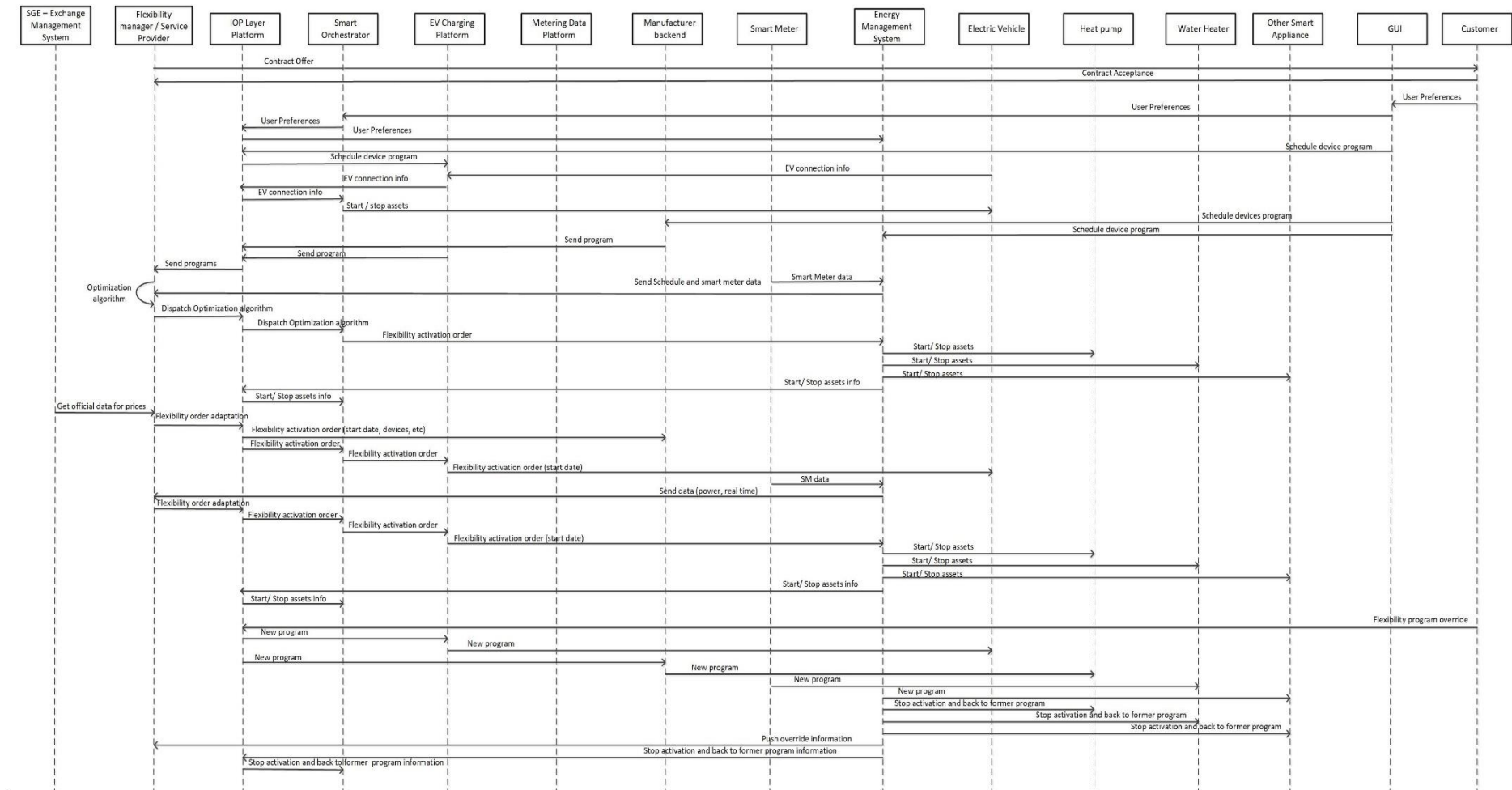

Source: JRC analysis, 2022.

## The Dutch Pilot Site

The project Interconnect has multiple pilot sites, one of which is the Dutch pilot site. Two main Use Cases are described: the first one has to do with planning of devices within the smart home to free up time of the users, whereas the second one deals with planning for a smart building.

- UC 1: Devices that can be controlled to free up time.

The goal of this UC is to facilitate the end-user to automate his/ her home. The user sets preferences in a GUI through an App as to how the energy smart appliances should be used. Based on these preferences, the system controls the functionality of these appliances.

**Figure 48.** Message Sequence Chart for UC 1 – Devices that can be controlled to free up time.

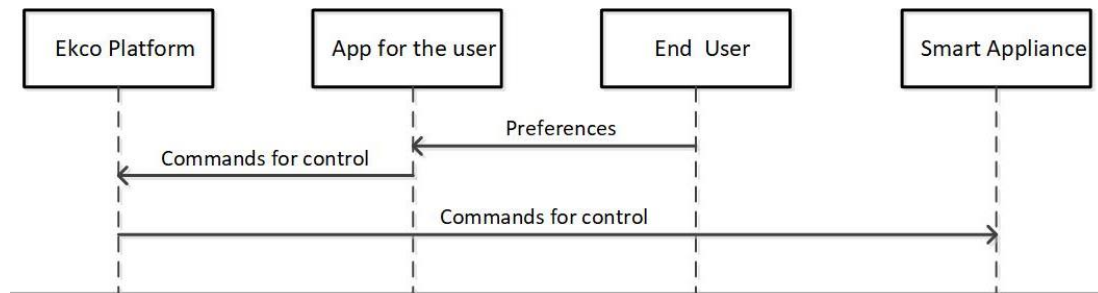

Source: JRC analysis, 2022.

- UC 2: Information Control.

This UC deals with smart buildings and their automation. A building management platform gathers data from all energy smart appliances. Based on this data, the platform automatically controls the functionality of these appliances in order to save energy.

Alternatively to the building manager, the control of the building can come from an external actor, i.e. an aggregator. The concept is similar, with the difference that in this case it is the aggregator to decide on the functionality of the energy smart appliances within the building.

**Figure 49.** Message Sequence Chart for UC 2 – Information control (control by building manager).

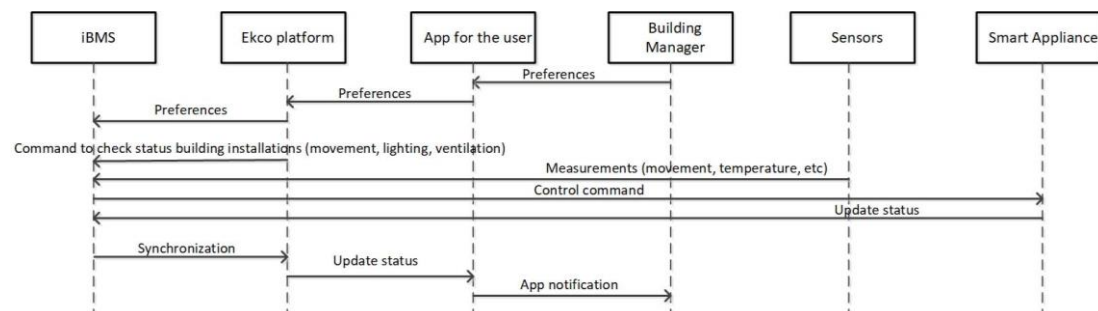

Source: JRC analysis, 2022.

**Figure 50.** Message Sequence Chart for UC 2 – Information control (control by aggregator).

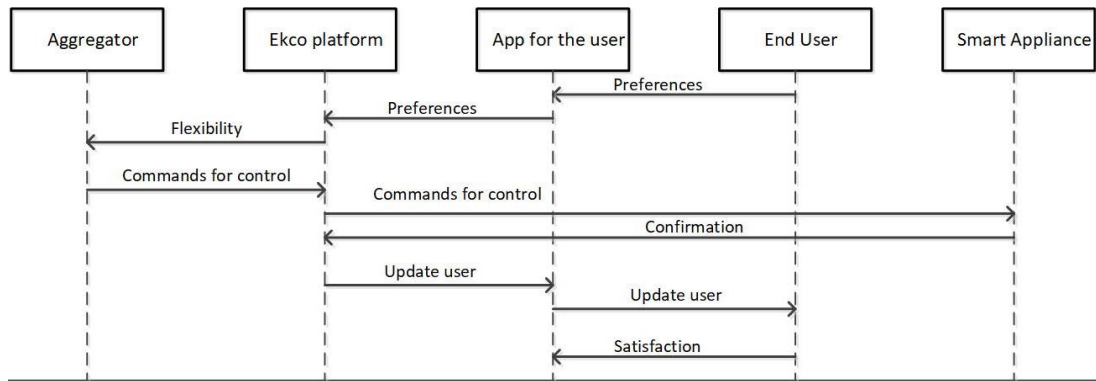

Source: JRC analysis, 2022.

### Representation of Use Cases on Smart Appliances based on Energy @home Technical Specification

Energy@home is a no-profit association targeting energy efficiency for homes. It promotes communication and collaboration among energy smart appliances within the house and also their connection to the smart grid. In their Technical Specification report <sup>(20)</sup> some Use Cases regarding energy smart appliances are presented and the interactions among them and other important actors, like the Home Gateway (equivalent to HEMS) and the user. In this work, we show the message sequence charts of the main Use Cases involving energy smart appliances within the Energy@home report aiming to demonstrate the interactions of such appliances with the rest of the energy actors and later on extract information about the data exchange principles. For this purpose, 4 UCs are presented as follows.

— UC 1: Visualization of consumption and price data.

The goal of this UC is to make visible to the end user the consumption data and also make available information like price tariffs for specific time periods.

**Figure 51.** Message Sequence Chart for UC 1 – Visualization of consumption data.

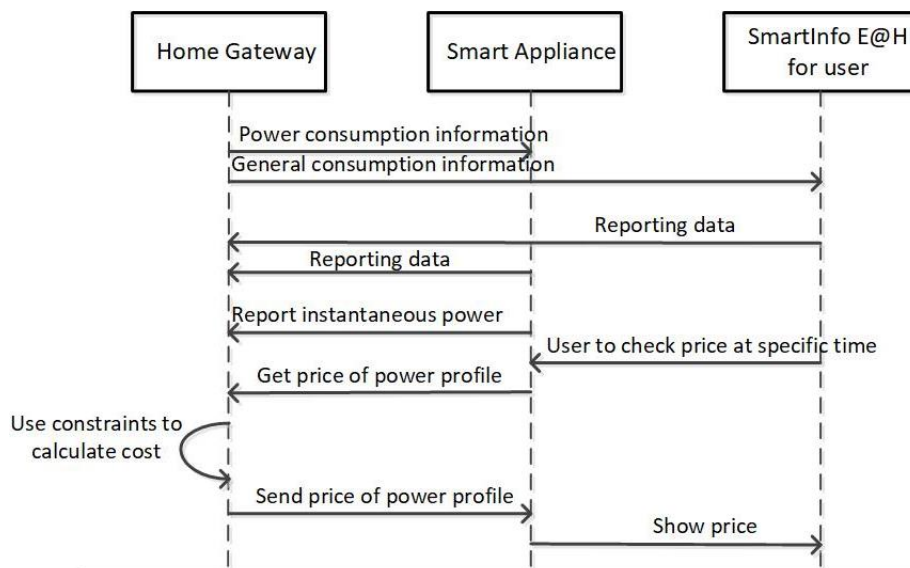

Source: JRC analysis, 2022.

<sup>(20)</sup> Energy@home Technical Specification, 2015 [Technical Specifications - All Documents \(energy-home.it\)](https://energy-home.it)



- UC 2: Setting of a smart appliance according to price tariffs.

In this UC, it is shown how the user makes the initial setting for a smart appliance and how this can change based on price information about tariffs in a specific period.

**Figure 52.** Message Sequence Chart for UC 2 – Setting of a smart appliance according to price tariffs.

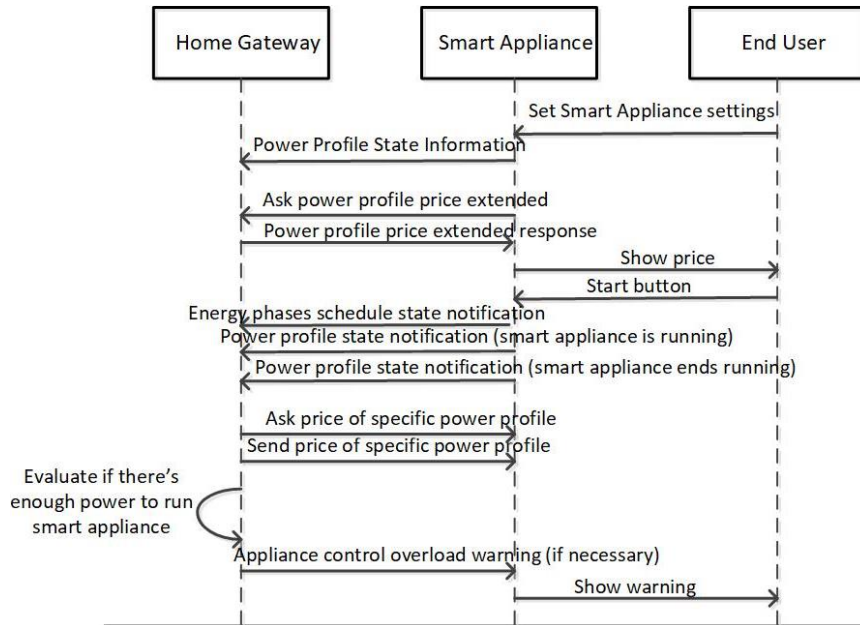

Source: JRC analysis, 2022.

- UC 3: Control of smart appliance in case of overload.

This UC shows the control of a smart appliance in case the available power is lower than the overall requested power. On such occasion, the smart appliance is ordered to pause its functionality and resume when the power will be sufficient.

**Figure 53.** Message Sequence Chart for UC 3 – Control of smart appliance in case of overload.

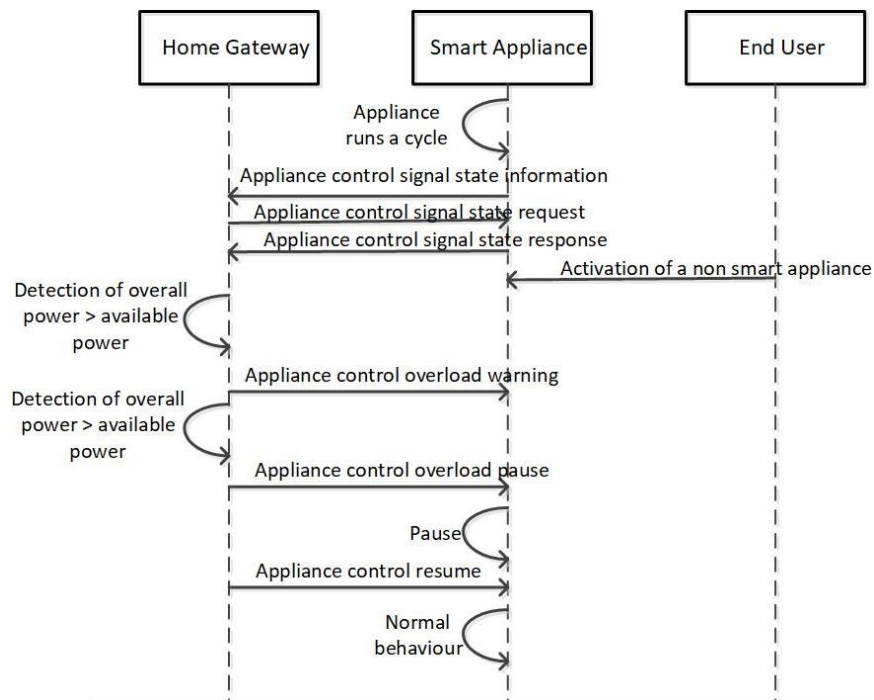

Source: JRC analysis, 2022.

— UC 4: Interaction of smart meter.

The goal of this UC is to show the interaction of the smart meter with the Home Gateway and the smart appliance(s). In this simple UC, the messages regarding consumption and production of power are the ones to be communicated.

**Figure 54.** Message Sequence Chart for UC 4 – Interaction of smart meter.

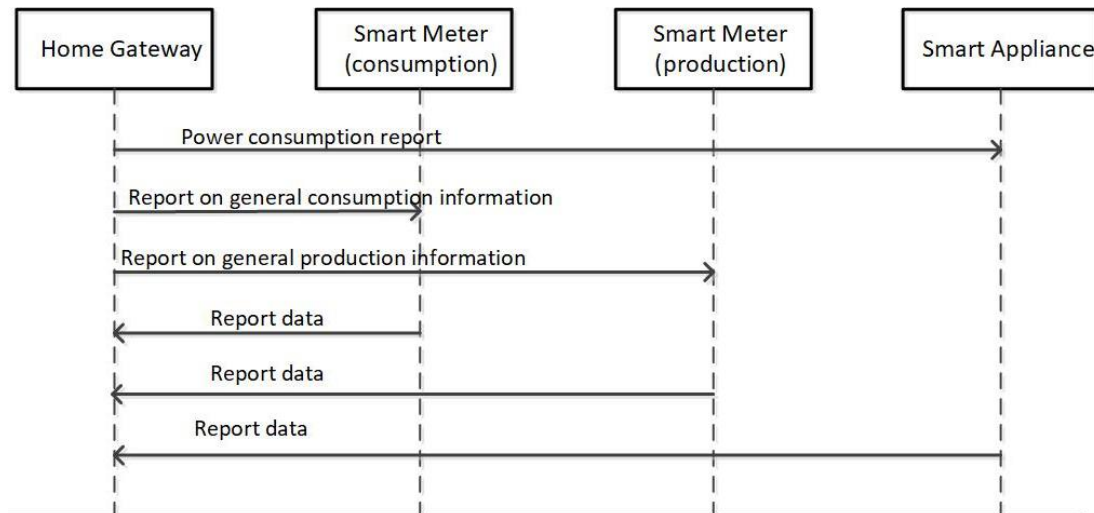

Source: JRC analysis, 2022.

## Annex 2: Using the Smart Applications Reference ontology (SAREF) to describe the General Use Cases

The four general Use Cases, referred in section 4.2, are here described using the classes defined in the Smart Applications Reference ontology or SAREF, hence establishing a link between any potential Use Case and this ontology. Each case is individually described in a few paragraphs, but a summary with the main information can be extracted from Table 11, page 65. All information regarding the SAREF ontology has been extracted from this ontology website <sup>(21)</sup> and a Technical Specifications <sup>(22)</sup>, both developed by ETSI.

Before mapping the aforementioned Use Cases with SAREF, we would like to provide a basic description of the ontology. A schematic description of its environment can be acquired from Figure 55. In total SAREF contains 81 classes -12 of them are defined as main classes-, 35 object properties and 5 data properties. The 12 main classes (and some additional ones) are depicted in Figure 55 using boxes and the object properties, which help to intra- and inter-connect classes, are found close to the connecting arrows. The data properties can be found inside the class *Device*, which is considered to be at the centre class of this ontology. The latter properties have suffered some alterations in the last couple of years.

An excellent short description of the various main classes involved in SAREF can be extracted from <sup>(23)</sup>. The study also validates the practical implementation of SAREF. We here summarize the description that they provided in such work. SAREF's central concept is the *Device*, which it is a tangible object designed to accomplish a particular *Task* (it could be more than one). To accomplish such task(s), the device performs a *Function* (it could be more than one). Functions need or have commands. A device needs to support a *Command* (or directive) to perform a certain function. Depending on the function(s) performed, a device can be in different *State*. If a device wants its function(s) to be discoverable, registerable, and remotely controllable by other devices in the network, it needs to expose these functions as a *Service*. A device can also have a *Profile*, which is nothing more than a specification to collect information about a certain *Property* or *Commodity* (e.g. Energy or Water). This information is then used for usage optimizing a certain resource in the location where the device is placed. A *Property* is defined as anything that can be sensed, measured or controlled by a device, and is associated to measurements. A *Measurement* is the measured value of a property and must be associated to

<sup>(21)</sup> More information about SAREF and its classes can be found in <https://saref.etsi.org/>

<sup>(22)</sup> ETSI TS 103 264 V3.1.1 (2020-02): “[SmartM2M: Smart applications: Reference Ontology and oneM2M Mapping](#)”

<sup>(23)</sup> van der Weerd, R., de Boer, V., Daniele, L., Nouwt, B. (2021). Validating SAREF in a Smart Home Environment. In: Garoufallo, E., Ovalle-Perandones, MA. (eds) *Metadata and Semantic Research. MTSR 2020. Communications in Computer and Information Science*, vol 1355. Springer, Cham. [https://doi.org/10.1007/978-3-030-71903-6\\_4](https://doi.org/10.1007/978-3-030-71903-6_4)

a *Unit of Measure* and a time stamp (*Time*). The *Feature of Interest* concept further allows to represent the context of a measurement, i.e., any real world entity from which a property is measured.

**Figure 55.** Overview of the main classes of the SAREF ontology.

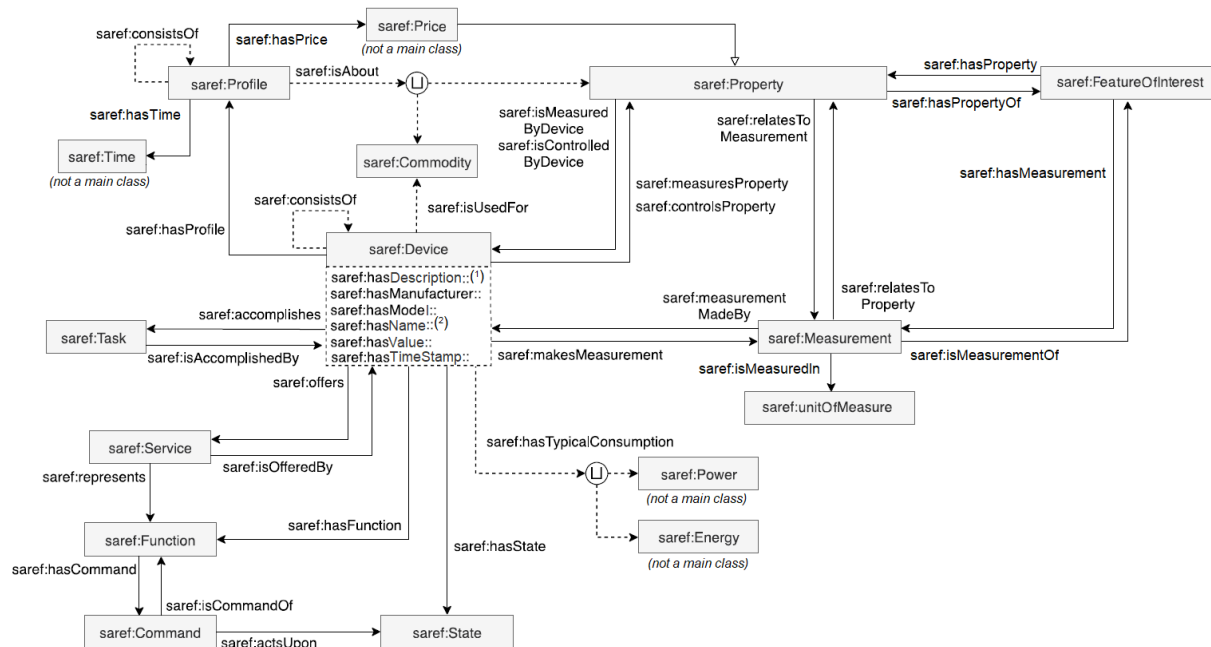

- (<sup>1</sup>) Deprecated: The use of `rdfs:comment` is recommended instead.
- (<sup>2</sup>) The `saref:hasName` property has been removed and the use of `rdfs:label` is recommended.

Source: <https://saref.etsi.org/core/v3.1.1/>, JRC analysis, 2022, and (<sup>24</sup>).

Throughout the current Annex, and aiming to assist to the reader’s comprehension, whenever one of the SAREF classes is stated or recalled a colon will precede its name, which will be in italics. For instance, the *SAREF class Device* will be referred simply as *:Device*. When referring to the possible multiple subclasses of a class, an “s” will be added to the superclass designated name, i.e., the different SAREF sub-classes of *Device* become *:Devices*. For the sake of simplification, only the main classes of SAREF, together with their direct subclasses, will be regarded in this annex. In addition, we would like to mention that in SAREF, *:Appliance* is an electrical or a mechanical machine that accomplishes some household functions. This is usually regarded as a white good outside this ontology.

#### **UC 4.2.1 Explicit Demand Response**

*“The Use Cases deal with energy smart appliances that are allowed to be controlled by an external party (DSO, aggregator, Energy Company, etc.). The flexibility status of the smart appliance is communicated to this external party, which subsequently turns on and off the smart appliance according to the needs of the system. Comfort boundaries are also taken into account, which are usually set by the end user.”* The Message Sequence Chart from Figure 14 is displayed once more in Figure 56 to assist in the reading of this report.

(<sup>24</sup>) ETSI TS 103 410-4 V1.1.2 (2020-05): [SmartM2M: Smart Appliances Extension to SAREF: Part 1: Energy Domain](https://www.etsi.org/standards-store/smartm2m)

**Figure 56.** Message Sequence Chart for the generic Use Case of explicit demand response.

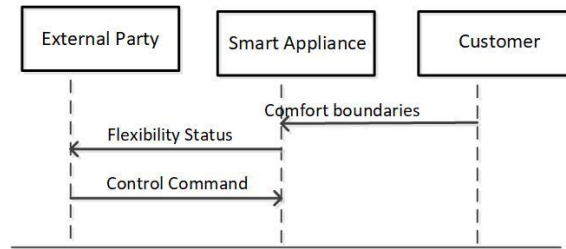

Source: Figure 14 of this report

In this UC there are three types of messages exchanged among three different entities, and each one of these exchanges can potential involve various SAREF classes. Considering a specific situation will narrow down the extensive variety of possibilities that could fit into this generic UC. For that reason, we consider that the only action that the external party –acting here as a controller– can perform on the energy smart appliances, is to turn them on or off. These appliances will extract their operation mode from the control commands received from the controller and the comfort boundaries set by the costumer/user.

Let as assume that the costumer has previously defined the following comfort boundaries:

**Table 9.** Consumer profile set for a more specific General UC defined in section 4.2.1.

| <i>Heating</i>   |                  | <i>Boiler</i>    |                  | <i>Illumination</i> |                  |
|------------------|------------------|------------------|------------------|---------------------|------------------|
| ON               | OFF              | ON               | OFF              | ON                  | OFF              |
| 5h-7h<br>17h-23h | 7h-17h<br>23h-5h | 5h-6h<br>17h-20h | 6h-17h<br>20h-5h | 17h-22h<br>6h-7h    | 7h-17h<br>22h-6h |

Source: JRC analysis, 2022.

The first action, that takes place in this UC, is that the user decides to define the settings for the home appliances implicated. In Table 9, we can see that there are three categories of appliances (in SAREF *:Devices*) that need to be considered. They fall into the following categories of Section 1.2; lightning appliances, HVAC (Heating Ventilation Air Conditioning), and continuous appliances (boiler). Although in the past *:Device* was regarded differently –see link <sup>(25)</sup>–, the corresponding four “*:Devices*” that are linked to this UC are the following:

- *:HVAC*,
- *:Meter* (i.e. devices built to detect and display a quantity in a form readable by a user),
- *:Actuator* (light switch), and;
- *:Appliance*.

The last two concern the illumination, which can be regarded from the actual device perspective to illuminate the environment (lights) or from the action of the user (switches). The *:Commodities* that are relevant for this case would be *:Electricity* and *:Gas*.

When considering which *:Functions* that would be necessary to accomplish the specific task(s), linked to *:Task*, for which the devices were designed, two *:Functions* are involved. We are talking about the *:ActuatingFunction*, which allows to transmit data to actuators (the switching between ON and OFF), and the *:MeteringFuntion*, which allows to get data from a meter or a display; the user may need to recheck the settings on the fly. All these functions will be discoverable, registerable, and remotely controllable in the network, hence the implication of *:Service*.

The series of commands exchanged between the different entities are included in *:Command*. For this specific example, *:OnCommand*, *:OffCommand*, and *:NotifyCommand* are engaged. The first two set the various devices in the desired state (i.e. *:OnState* / *:OffState*). The latter is used by the devices to notify their flexibility status to the external controller.

<sup>(25)</sup> <https://ontology.tno.nl/saref/>

Different physical elements (:Property), or their qualities (:FeatureOfInterest), are measured. They are :Light and :Temperature, and the action of measurement is represented by the :Measurement. Such class leads to the need of another element, the :UnitOfMeasurement, and a couple of subcategories :IlluminanceUnit, and :TemperatureUnit. Two additional main class are also implicated: :Time, which it is introduced by the user when the activation times of the various appliances, or :Device, are programmed; and :Profile, which has been introduced by the definition of the comfort boundaries.

#### UC 4.2.2 Explicit Demand Response

"In this category of Use Cases, the energy smart appliances receive price/tariff information by an external party (DSO, aggregator, Energy Company, etc.) and subsequently decide to alter consumption or production, so as to minimize energy consumption or maximize electricity production fee." The Message Sequence Chart from Figure 15 is here displayed once more to assist in the reading of this report.

The first thing to be noticed from this general UC is that the appliances have the capacity to regulate themselves altering some specific profile (comfort boundaries), which has to be set by the user and it is based on the price information received from the external party. Another important modification, comparing against the previous UC, comes from the role that the external party plays; it does not act as a controller any more. Since the appliances do not receive commands from any entity, but from themselves, they act as individual and independent controllers. In order to simplify the current case, we assume that the appliances are set to obey a specific :Profile, set manually by the users in advance.

Figure 57. Message Sequence Chart for the generic use case of implicit demand response.

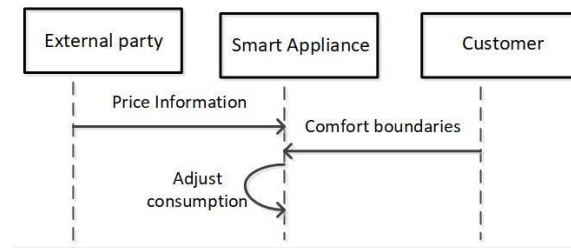

Source: Figure 15 of this report

Due to their self-adjustment capacity, the appliances have the need to sense the environment of the household unit to know if they are complying -or not- with the comfort boundaries. If the appliances do not comply, they will have to auto adjust their parameters to do so. We assume that some sensing devices are placed around the household unit, or on the devices themselves. These provide all the necessary information for the devices to self-regulate into the proper state; allowing them to meet the above mentioned configurations. For this reason, we introduce sensor devices in this example.

It has to be taken into consideration that, if the user do not adjust certain minimum temperature levels in the heating and the boiler, these appliances will be able to set themselves to very low values, or even to deactivate themselves. A similar event will happen for the illumination if low energy consumption lighting devices are not been installed. Although there could be warnings or emergency triggers activated to prevent this situations, we take for granted that the customer has foreseen both situations and has defined the following preferred comfort boundaries:

Table 10. Consumer profile set for a more specific General UC defined in section 4.2.2.

| Heating   |        | Boiler  |        | Illumination |        | Additional Energy profile   |
|---|--------|---------|--------|--------------|--------|---|
| <i>Preferred status (subdued to energy profile)</i> |        |         |        |              |        | <u>Status to be complied</u>  |
| 22°C  | 18°C   | ON      | OFF    | ON           | OFF    | General Energy Profiles:<br>Saving Cost. (Price information from external party). |
| 5h-7h   | 7h-17h | 5h-6h   | 6h-17h | 17h-22h      | 7h-17h |   |
| 17h-23h   | 23h-5h | 17h-20h | 20h-5h | 6h-7h        | 22h-6h |   |

Source: JRC analysis, 2022.

It would seem that for this UC we would need further subclasses of :Command and :State available, because there are more :Task to be managed. However, since they are set and controlled by the very same appliances,

we cannot talk about any *:Command* being implicated but one, the *:NotifyCommand*. There still exist notifications received by the appliances from the external party and the consumer. Conversely, it is true that the appliances can be configured in a wider range of states. These are represented by those previously named and some additional ones, such as *:OpenCloseState*, *:StartStopState* and *:MultiLevelState*. Each *:Device* needs to decide what to do depending on the *:Price* information received, the *:Profile* set by the customer (here Saving Cost), and the information received from sensors.

As mentioned above, besides the *:Devices* already introduced in the previous UC, there is a new subclass involved, *:Sensor*. It concerns the devices that detects and responds to events or changes in the physical environment (light, motion, or temperature changes). In addition, the adoption of sensors admits for the two remaining *:Functions* to be included. They are the *:EventFunction*, which allows to notify about some relevant activity, and the *:SensingFunction*, which allows to transmit data from sensors. On the other hand, the appliances self-adjustment capacity makes the need of an external controller obsolete, hence the *:Service* is not active in this UC.

The presence of the price information in the Message Sequence Chart, together with the *:Profile*, enables the involvement of additional *:Properties*, which are *:Price*, *:Energy*, and *:Power*. Due to these new classes, we can include further units of measurement, which respectively are *:Currency*, *:EnergyUnit*, and *:PowerUnit*.

Some possible additional features for this UC could also include sensors that mechanically control windows or blinds. Such sensors could optimize further the required energy profile (Saving Cost), and they would enable another class within *:Devices*, called *:Actuator*, responsible for moving or controlling a mechanism or system by performing an actuating function. This additional feature would also enable new *:Commands* like *:OpenCommand* and *:CloseCommand*. Moreover, depending on the sensors present in the household unit, it would also be possible to include additional *:Properties* like, *:Humidity*, *:Motion*, and *:Occupancy*. For instance, the sensor could detect the presence –or non-presence– of user in the premises, consequently activating –or deactivating– the lights.

### UC 4.2.3 Local Optimal Energy Consumption

*“In this category of Use Cases, everything takes place at the consumer’s premises. The key point here is a local controller, which has access to energy production data (i.e. from PVs) and also consumption data (i.e. from smart meters). So, it decides when it is best to turn on and off the energy smart appliances within the house based on the above information. These appliances communicate with the controller by sending their flexibility status.”* The Message Sequence Chart from Figure 16 is here displayed once more to assist in the reading of this report.

**Figure 58.** Message Sequence Chart for the generic use case of local optimal energy consumption.

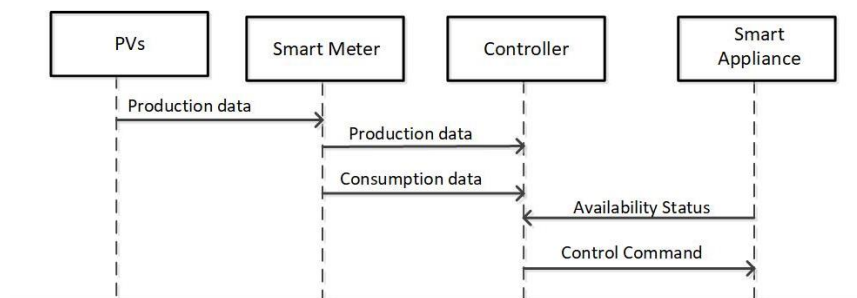

Source: Figure 16 of this report

This current general UC is the one that has more entities present; hence, there are almost twice as many messages exchanges among the different parties when comparing with the two previous examples. The entities involved are:

- A local controller that has the ability to decide when it is better to use the PVs.
- Several smart appliances that could be easily represented by Table 10, plus additional white goods.
- Photovoltaic panels (PVs), which will be considered as the sole power input of the system.
- A smart meter that can measure locally the production of energy.

Almost the whole SAREF ontology comes into play when describing this UC, but the number of classes implicated could be expanded even further. In order to reduce its complexity, we will disregard the sensors employed in the previous case, although we will keep them as optional in Table 11 -last section of the current annex-. We will not repeat the mapping of this UC with classes *:Device*, *:Function*, *:Property*, *:State*, and *:UnitOfMeasurement*; because it has already been done for the previous cases. In addition, even though there is no Price Information message exchange between an external party and the system, we can assume that the information is provided by the smart meter, which is well interconnected with the energy provider. For this reason, we will also regard the price information as optional in Table 11.

In the current UC almost all *:Commands* becomes available to the local controller. We talk about *:CloseCommand*, *:GetCommand*, *:NotifyCommand*, *:OffCommand*, *:OnCommand*, *:PauseCommand*, *:SetlevelCommand*, *:StartCommand*, *:StepdownCommand*, *:StepupCommand*, *:StopCommand*, and *:ToggleCommand*. At the same time, it is possible for the appliances to be in a broader range of states, described by the *:OnOffState*, the *:StartStopState*, and the *:MultiLevelState*.

The devices directly comprised are *:HVAC*, *:Meter*, *:Lightning*, *:Actuator*, and *:Appliances* (white goods). All of them are link to the *:Task* and their immediate functions include *:ActuatingFunction* and *:MeteringFunction*. There is only one *:Commodity* involved, the *:Electricity*, and the *:Profile* intervenes once more. Several *:Properties* take part in the UC, but it is the *:Energy* the one that plays a major role due to the presence of the PVs as a sole power input. Both *:Light* and *:Temperature* could also be regarded if we consider the common elements from Table 9 and Table 10, from the previous UCs. Each *:Property* is linked to a *:Measurement* and its respective *:FeatureOfInterest*, and it has its specific *:UnitOfMeasurement*, here involving directly the *:EnergyUnit*, and indirectly both *:IlluminanceUnit*, and *:TemperatureUnit*. Once more, due to the presences of a controller, there exist an involvement of the *:Service*. Since there is a time concept introduced both by this controller and the PVs, the *:Time* is also covered.

#### UC 4.2.4 Standalone Demand Response

“In this category of Use Cases, everything takes place within the smart appliance. It is able to measure specific grid parameters, like voltage and frequency. When one of them exceeds a specific value, it regulates the consumption so as to benefit the grid.” The Message Sequence Chart from Figure 17 is here displayed once more to assist in the reading of this report.

**Figure 59.** Message Sequence Chart for the generic Use Case of Standalone demand response.

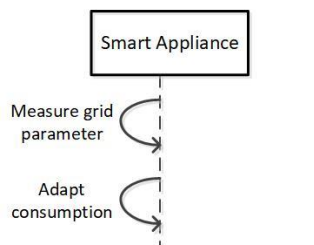

Source: Figure 17 of this report.

This UC is quite related to the UC 4.2.2., but now the appliances here represented are smarter and more autonomous. In this case we do not even have the *:NotifyCommand* because the appliances do all the work. Let us consider, for the sake of simplification, that there is a unique appliance and that it is an ultra-smart washing machine. Something that may not exist nowadays, but that perhaps may be available in a few years' time. However, if we were to considered this smart appliance to be a smart thermostat, it does not sounds that much out-of-reach.

There is absolutely none involvement of the *:Command*, and due to the election of these sole ultra-smart device, there is only one *:Commodity* and one *:Device* implicated, these are *:Electricity* and *:Appliance*, respectively. The washing machine has all available *:Functions* and *:Statuses*. For instance, it can open and close its own door. It only has the need to measure two *:Properties*, these are *:Energy* and *:Price*, with their respectively *:UnitOfMeasurement*, which are *:Currency* and *:EnergyUnit*. Hence, *:Measurement* is also employed, but so are *:Task*, *:Time*, *:Profile* and obviously *:FeatureOfInterest*. This use case does not accounts for the *:Service*.

The example here presented is an oversimplification of what a UC could be. The main contribution of this instance is to demonstrate how the SAREF ontology can strongly described any specific UC, even with one as

simple as this o. The UC follow the essential characteristics that a smart appliance has to possess in order to be able to Demand Side Flexibility.

**Link between the SAREF Ontology and the Representation of Use Cases on Smart Appliances based on the Ecodesign Preparatory Study on Smart Appliances, Task 7**

**Table 11.** Mapping each general UC, described in all four sections of this annex, with the SAREF ontology.

| SAREF               |                                  | General Categorization of Use Cases |                          |                                  |                            |
|---------------------|----------------------------------|-------------------------------------|--------------------------|----------------------------------|----------------------------|
| Main Classes        | Sub-Classes                      | Explicit Demand Response            | Implicit Demand Response | Local Optimal Energy Consumption | Standalone Demand Response |
| Command             | CloseCommand                     |                                     |                          | O                                |                            |
|                     | GetCommand <sup>(1)</sup>        |                                     |                          | X                                |                            |
|                     | NotifyCommand                    | X                                   | X                        | X                                |                            |
|                     | OffCommand                       | X                                   |                          | X                                |                            |
|                     | OnCommand                        | X                                   |                          | X                                |                            |
|                     | OpenCommand                      |                                     |                          | O                                |                            |
|                     | PauseCommand                     |                                     |                          | X                                |                            |
|                     | SetlevelCommand <sup>(1)</sup>   |                                     |                          | X                                |                            |
|                     | StartCommand                     |                                     |                          | X                                |                            |
|                     | StepdownCommand                  |                                     |                          | X                                |                            |
|                     | StepupCommand                    |                                     |                          | X                                |                            |
|                     | StopCommand                      |                                     |                          | X                                |                            |
| ToggleCommand       |                                  |                                     | X                        |                                  |                            |
| Commodity           | Coal                             |                                     |                          |                                  |                            |
|                     | Electricity                      | X                                   | X                        | X                                | X                          |
|                     | Gas                              | X                                   | X                        |                                  |                            |
|                     | Water                            |                                     |                          |                                  |                            |
| Device              | Actuator                         | X                                   | O                        | X                                |                            |
|                     | Appliance <sup>(1)</sup>         |                                     |                          | O                                | X                          |
|                     | HVAC                             | X                                   | X                        | X                                |                            |
|                     | Meter                            | X                                   | X                        | X                                |                            |
|                     | Sensor <sup>1</sup>              |                                     | X                        |                                  |                            |
| Feature Of Interest |                                  | X                                   | X                        | X                                | X                          |
| Function            | ActuatingFunction <sup>(1)</sup> | X                                   | O                        | X                                | X                          |
|                     | EventFunction                    |                                     | X                        | O                                | X                          |
|                     | MeteringFunction                 | X                                   | X                        | X                                | X                          |
|                     | SensingFunction                  |                                     | X                        | O                                | X                          |
| Measurement         |                                  | X                                   | X                        | X                                | X                          |
| Profile             |                                  | X                                   | X                        | X                                | X                          |
| Property            | Energy                           |                                     | X                        | X                                | X                          |
|                     | Humidity                         |                                     | O                        | O                                |                            |



|                     |                               |   |   |   |   |
|---------------------|-------------------------------|---|---|---|---|
|                     | Light                         | X | X | X |   |
|                     | Motion                        |   | O | O |   |
|                     | Occupancy                     |   | O | O |   |
|                     | Power                         |   | X | O |   |
|                     | Pressure                      |   |   |   |   |
|                     | Price                         |   | X | O | X |
|                     | Smoke                         |   |   |   |   |
|                     | Temperature                   | X | X | X |   |
| Service             | Switch on service             | X |   | X |   |
| State               | MultiLevelState               |   | X | X | X |
|                     | OnOffState <sup>(1)</sup>     | X | X | X | X |
|                     | OpenCloseState <sup>(1)</sup> |   | O | O | X |
|                     | StartStopState <sup>(1)</sup> |   | X | X | X |
| Task                |                               | X | X | X | X |
| Time <sup>(2)</sup> |                               | X | X | X | X |
| Unit Of Measurement | Currency                      |   | X | O | X |
|                     | EnergyUnit                    |   | X | X | X |
|                     | IlluminanceUnit               | X | X | X |   |
|                     | PowerUnit                     |   | X | O |   |
|                     | PressureUnit                  |   |   |   |   |
|                     | TemperatureUnit               | X | X | X |   |

O Class and/or subclass possibly involved in the specific example representing the UC.

X Class and/or subclass definitely involved in the specific example representing the UC.

<sup>(1)</sup> SAREF subclass with additional, and more specific, sub-subclasses available.

<sup>(2)</sup> The SAREF class Time is regarded as a subclass of the SAREF class Property in the SAREF ontology from TNO ([link](#)), but as a main class in Official ETSI portal for SAREF ([link](#)). The latter is adopted as reference; quotes 2021 instead of 2020.

Source: JRC analysis, 2022.

### **SAREF4ENER: The SAREF Extension Assisting on Managing the Flexibility of Home Energy Domain**

There are some particular domain where SAREF <sup>(22)</sup> interoperability language has been extended. These are domains concerning Energy, Environment, Building, Smart Cities, Industry and Manufacturing, Smart Agriculture and Food Chain, Automotive, eHealth/Ageing-well, Wearables, Water and Smart Lifts domains –for more info see <sup>(26)</sup>–. The one that it is of our interest is the first, which expands the energy domain, it is referred in a specific technical specification from ETSI (like all the other extensions) as SAREF4ENER <sup>(24)</sup>. It is an extension of SAREF that was created in collaboration with Energy@Home <sup>(27)</sup> and EEBus <sup>(28)</sup>, which are major Italy and Germany-based industry associations, respectively, who are working to enable the interconnection of their data models. On the one hand, the Italian association develops and promotes energy efficiency in smart homes, looking at the interaction between user devices and the energy infrastructure. Using their own description, “*the Energy@Home is a no-profit association that, for the benefit of the environment, aims at developing & promoting technologies and services for energy efficiency in the home based upon device to device communication*”. On the other hand, the German association is more focused in the Internet of Things, from the smart and renewable energy perspective. Quoting their description: “*With its standardized use cases, EEBUS offers solutions in the fields of digital grid connection, increase of self-consumption and comfort. The digital*

<sup>(26)</sup> <https://saref.etsi.org/extensions.html>

<sup>(27)</sup> <http://www.energy-home.it>

<sup>(28)</sup> <http://www.eebus.org/en>

grid connection enables load management at building level and the use of time-of-use tariffs to provide grid support and price-optimized operation of devices.”

In particular, SAREF4ENER is an OWL-DL <sup>(29)</sup> ontology that expands SAREF with 63 new classes and 17 properties <sup>(30)</sup>. As mentioned, it was created to allow the interoperability among various data systems and energy smart appliances developed by different consortia in the smart home domain. By using SAREF4ENER, energy smart appliances from different manufacturers, supporting either EEBus or Energy@Home data models, will be able to understand each other using any EMS, both at home and in the cloud. Its main scope is focused on demand response scenarios, by providing a tool for flexibility, which can be offered by customers to the Smart Grid. The latter can manage the registered energy smart appliances by means of a Customer Energy Manager (CEM). For a better understanding of this specific extension called SAREF4ENER, read section “Introduction and overview” from <sup>(24)</sup>.

### Annex 3: Information Exchange between Main Actors and Energy Smart Appliances

For a more compact displayed of the information introduced in section 5.2, in particular the messages exchanged between energy smart appliances and the four actors collected in Table 4, Table 5, Table 6, and Table 7, we mix all messages introduced in a unique table. In Table 12, along the messages gather in from the state-of-the-art uses cases under scrutiny, we introduce some extra information (messages). The generated sections, subsections and additional messages come either because they are indirectly imply, or because they make the information already present more consistent. In addition, some of these messages have been slightly adapted (because they are synonymous messages) to fall into the categorization produced. Some extra categories of messages, or messages themselves, could be included if additional use cases were to be included in the current study.

**Table 12.** Grouping of messages exchanged between the four actors and energy smart appliance referred in section 5.2.

|                           |                                      | 0 – Energy Smart Appliance                  |     |                         |     |                  |     |                        |     |   |
|---------------------------|--------------------------------------|---|-----|-------------------------|-----|------------------|-----|------------------------|-----|---|
|                           |                                      | 2.4.1                                       |     | 2.4.2                   |     | 2.4.3            |     | 2.4.4                  |     |   |
|                           |                                      | Consumer control point                      |     | Energy service provider |     | Customer         |     | Provider control point |     |   |
| Data / Messages exchanged |                                      | 0←1   | 0→1 | 0←2                     | 0→2 | 0←3              | 0→3 | 0←4                    | 0→4 |   |
| Data management           | Control Commands (CC) <sup>(1)</sup> | Switch On/Off                               | X   |                         | X   |                  | X   |                        | X   |   |
|                           |                                      | Schedule of activation/deactivation         | X   |                         | X   |                  |     |                        | X   |   |
|                           |                                      | Schedule time slot: Active/ Non-active      | X   |                         | X   |                  |     |                        | X   |   |
|                           |                                      | Time window duration                        | X   |                         | X   |                  |     |                        | X   |   |
|                           |                                      | Override commands / stop activation         | X   |                         | X   |                  |     |                        | X   |   |
|                           | Energy                               | Store                                       | X   |                         | X   |                  |     |                        | X   |   |
|                           |                                      | Reduce                                      | X   |                         | X   |                  |     |                        | X   |   |
|                           |                                      | Consume (total/end-task/real-time)          | X   | X                       |     | X                | X   |                        |     |   |
|                           |                                      | Produce (total/end-task/real-time)          |     | X                       |     | X                | X   |                        |     |   |
|                           | Feedback CC <sup>(1)</sup>           | General acknowledge / Update <sup>(1)</sup> |     | X                       |     | X                |     | X <sup>(1)</sup>       |     | X |
|                           |                                      | Conflicting message <sup>(1)</sup>          |     | X <sup>(1)</sup>        |     | X <sup>(1)</sup> |     |                        |     |   |
|                           |                                      | User presence or preferences <sup>(1)</sup> |     |                         |     |                  |     | X <sup>(1)</sup>       |     |   |
|                           |                                      | Stored                                      |     |                         |     |                  |     |                        |     |   |
|                           |                                      | Energy consumed                             |     | X                       |     | X                |     | X                      |     | X |
|                           | Energy produced                      |   | X   |                         | X   |                  | X   |                        | X   |   |

<sup>(29)</sup> See the World Wide Web Consortium (W3C) for the definition of OWL-DL (<https://www.w3.org/TR/owl-guide/>)

<sup>(30)</sup> Check <https://saref.etsi.org/saref4ener/v1.1.2/> to know more about classes and properties of SAREF

|                     |                                       |   |   |   |   |                  |                  |                  |   |                  |
|---------------------|---------------------------------------|---|---|---|---|------------------|------------------|------------------|---|------------------|
| Flexibility         | Request                               | Availability status / Status update         | X |   | X |                  |                  | X                |   |                  |
|                     |                                       | Price information/ Tariffs                  |   | X |   | X <sup>(1)</sup> | X <sup>(1)</sup> |                  | X |                  |
|                     |                                       | Schedule of charging                        |   |   |   |                  |                  |                  |   |                  |
|                     |                                       | Control override                            |   |   |   |                  |                  | X                |   |                  |
|                     | Broadcast <sup>(1)</sup>              | Availability status / Status update         |   | X |   | X                |                  | X                |   | X                |
|                     |                                       | Price information/ tariffs                  | X |   | X |                  |                  | X                |   | X <sup>(1)</sup> |
|                     |                                       | User presence or preferences <sup>(1)</sup> |   |   |   |                  |                  | X <sup>(1)</sup> |   |                  |
|                     |                                       | Control overwrite event (external actor)    |   |   |   |                  | X <sup>(1)</sup> | X                |   |                  |
| Comfort boundary    | Time slots for on/ off                |   |   |   |   | X                |                  |                  | X |                  |
|                     | Duration of on/ off time slots        |   |   |   |   | X                |                  |                  | X |                  |
|                     | temperature limits                    |   |   |   |   | X                |                  |                  | X |                  |
| Warning / Emergency | Emergency turn On/off                 |   |   |   |   |                  | X                |                  |   |                  |
|                     | Warning <sup>(1)</sup>                |   |   |   |   |                  |                  |                  |   |                  |
|                     | Overload - consumption exceeds limits | X   |   |   |   |                  |                  |                  |   |                  |
|                     | Critical parameter notification       |   |   | X |   |                  |                  | X                |   |                  |
| Control actions     | Manual Switch: On/Off                 |   |   |   |   | X <sup>(1)</sup> |                  |                  |   |                  |
|                     | Adjust/Adapt consumption              |   |   |   |   | X <sup>(1)</sup> |                  |                  |   |                  |
|                     | Activation of a non-smart appliance   |   |   |   |   | X                |                  |                  |   |                  |

Source: JRC analysis, 2022

<sup>(1)</sup> Information or messages not present on Table 4, Table 5, Table 6, and Table 7. They have been added to make the table more complete or because they are indirectly implied.

Note: The title of some messages have been rephrased to fit the different categories.

## **GETTING IN TOUCH WITH THE EU**

### **In person**

All over the European Union there are hundreds of Europe Direct information centres. You can find the address of the centre nearest you at: [https://europa.eu/european-union/contact\\_en](https://europa.eu/european-union/contact_en)

### **On the phone or by email**

Europe Direct is a service that answers your questions about the European Union. You can contact this service:

- by freephone: 00 800 6 7 8 9 10 11 (certain operators may charge for these calls),
- at the following standard number: +32 22999696, or
- by electronic mail via: [https://europa.eu/european-union/contact\\_en](https://europa.eu/european-union/contact_en)

## **FINDING INFORMATION ABOUT THE EU**

### **Online**

Information about the European Union in all the official languages of the EU is available on the Europa website at: [https://europa.eu/european-union/index\\_en](https://europa.eu/european-union/index_en)

### **EU publications**

You can download or order free and priced EU publications from EU Bookshop at: <https://publications.europa.eu/en/publications>. Multiple copies of free publications may be obtained by contacting Europe Direct or your local information centre (see [https://europa.eu/european-union/contact\\_en](https://europa.eu/european-union/contact_en)).

## The European Commission's science and knowledge service

Joint Research Centre

### JRC Mission

As the science and knowledge service of the European Commission, the Joint Research Centre's mission is to support EU policies with independent evidence throughout the whole policy cycle.



**EU Science Hub**  
[ec.europa.eu/jrc](https://ec.europa.eu/jrc)



@EU\_ScienceHub



EU Science Hub - Joint Research Centre



EU Science, Research and Innovation



EU Science Hub



Publications Office  
of the European Union